

March 2009

# The Engaged Organization

Corporate Employee Environmental Education  
Survey and Case Study Findings



Business & Environment

**National Environmental Education Foundation Business and Environment Program:  
Aligning corporate sustainability values and day-to-day business practices**



is a program of



***Knowledge to Live By***

The National Environmental Education Foundation (NEEF) provides knowledge to trusted professionals who, with their credibility, amplify messages to national audiences to solve everyday environmental problems. Together, we generate lasting positive change.

NEEF partners with professionals in health, education, media, business and public land management to promote daily actions for helping people protect and enjoy the environment. Through our primary programs — Classroom Earth, National Public Lands Day, National Environmental Education Week, Business and Environment, Earth Gauge® and Health & Environment — we offer Americans knowledge to live by. To learn more, call (202) 833-2933 or visit [www.neefusa.org](http://www.neefusa.org).

[www.neefusa.org](http://www.neefusa.org)  
4301 Connecticut Avenue, Suite 160  
Washington, DC 20008  
202-833-2933

© March 2009, National Environmental Education Foundation.



# Table of Contents

<b>Acknowledgements</b> .....	iv
<b>Welcome from Ken Strassner and Diane Wood</b> .....	v
<b>Executive Summary</b> .....	vii
<b>Introduction</b> .....	1
<b>Survey Findings</b> .....	2
<b>Case Studies</b> .....	13
<i>Large Companies</i>	
Cisco.....	16
Hewlett-Packard.....	20
Interface.....	23
Johnson & Johnson.....	26
Wal-Mart.....	29
<i>Medium Companies</i>	
Stonyfield.....	34
The Accessory Corporation.....	36
<i>Small Company</i>	
Clean Clothes, Inc. (Maggie's Organics).....	38
<b>Conclusion: Lessons Learned and Needs Identified</b> .....	41
<b>Appendices:</b>	
Survey questions.....	43
Case study questions.....	47



## Acknowledgements

The National Environmental Education Foundation (NEEF) would like to thank Kimberly-Clark for their generous support of the Business & Environment Program and this report.



NEEF would also like to thank the Business & Environment Program Advisory Committee and friends\* of the committee:

**Ken Strassner** (Chair) vice-president, Global Environment, Safety, Regulatory and Scientific Affairs, Kimberly-Clark Corporation; **Andrew Aulisi** director of Markets and Enterprise Program, World Resources Institute; **Gordon Binder**\* project consultant, senior fellow, World Wildlife Fund; **Tom Davis**\* Tom Davis Associates, LLC; **Amy Goldman** director, Global Environmental Management Initiative; **Thomas Higgins** vice-president and relationship manager, Not-for-Profit Professional Services, HSBC Bank USA; **Sarah Howell** formerly, director, Environmental & Corporate Communications, BP, plc.; **Michael Kane**\* senior advisor, Office of Policy, Economics and Innovation, Environmental Protection Agency; **Agata Kostecka**\*

manager, Sustainability Program, Corporate Executive Board; **Joyce LaValle**\* senior vice-president of Associate and Customer Engagement, Interface Flooring Systems, Inc.; **Margaret Lindeman** environmental strategy program manager in energy, environment, safety and health, Lockheed Martin; **Carol Singer Neuvelt** executive director, NAEM; **Trish Silber** president, Aliniad Consulting Partners, Inc.; **Meredith Smith** vice-president Climate Marketing, The Weather Channel; **Mark Starik** department chair and professor of Strategic Management and Public Policy, George Washington University; **Meredith Armstrong Whiting** senior research fellow, Global Corporate Citizenship, Conference Board.

Finally, NEEF would like to express special thanks to the many organizations who helped to distribute the survey and who agreed to participate in our case study interviews:

Bank of America; British American Business Council; British Telecom, Inc.; Cisco Systems, Inc.; Clean Clothes, Inc. (Maggie's Organics); Co-op America; Corporate Environmental Health and Safety Roundtable; Environmental Banking Association; Gap Inc.; General Motors, Inc.; Greenbiz; Hewlett-Packard Company; HydroPoint Data Systems, Inc.; IKEA, Inc.; Interface, Inc.; Johnson & Johnson, Inc.; New American Dream Responsible Purchasing Network; Office Depot, Inc.; Stonyfield, Inc; The Accessory Corporation, Inc.; Verizon, Inc.; Wachovia; Wal-Mart, Inc.; Warner Bros., Inc.; Xerox, Inc.

This report was prepared by Krista Gullo and Leah Haygood of BuzzWord, with special thanks to Tracy Fisher, former special director at NEEF for early development of the survey and report, and Jennifer Errick for design.



March 2009

## Welcome from Ken Strassner and Diane Wood

This report addresses what we believe is a very timely topic in the evolution of the business-environment nexus. When the modern U.S. environmental movement began in the 1970s, it relied largely on regulation to reduce negative environmental impacts. Companies responded by creating centers of environmental expertise within their organizations. The major focus of a second wave of corporate environmentalism, which began during the late 1980s, was on demonstrating the business value of environmental sustainability to the executive suite. We are now in a third phase in which leading companies recognize that greening their products and operations is a source of value and that all employees must be engaged in the effort to ensure its success. In the 21st century, all jobs are green jobs.



Businesses already know that environmental education matters. Environmentally educated employees can improve a business' bottom line. In tough economic times, sustainability practices save money and reduce impact on the environment.

The National Environmental Education Foundation (NEEF) set out to explore the current landscape — how far we've come in this third phase — by researching how companies are engaging and educating their employees on environmental issues. This report contains findings of NEEF's groundbreaking survey and case studies.



The results of the survey and case studies suggest that environmental education is becoming standard practice at many companies though clearly there is no one-size-fits-all model. Most promising is how many companies see that environment and sustainability (E&S) knowledge is valuable, particularly for new hires, and expect it to increase in importance as a hiring factor.

This is an opportune time for companies to share best practices related to employee environmental education and learn from one another. Through this report and other activities, we seek to share the learning and promote further progress.

We hope you find the findings presented in the report useful, and welcome your feedback.

Sincerely,

**Ken Strassner**

Vice-President, Global Environment,  
Safety, Regulatory and Scientific Affairs,  
Kimberly-Clark Corporation and  
Business & Environment Program Advisory Committee Chair

**Diane Wood**

President, National Environmental Education Foundation





With the recent explosion of all things “green,” leading companies are recognizing the valuable, indeed essential, role their employees play in aligning day-to-day operations with corporate values regarding the environment and sustainability.



## Executive Summary

The goal of NEEF's business and environment program is to help companies engage their employees directly to understand how their actions can contribute to achieving environmentally superior performance.

With the recent explosion of all things "green," leading companies are recognizing the valuable, indeed essential, role their employees play in aligning day-to-day operations with corporate values regarding the environment and sustainability. While environmental management used to be the province of specialists, responding to environmental challenges is now so fundamental to a company's success that environmental knowledge cannot be isolated within an organization, but must be pervasive. In other words, all jobs are green jobs.

In a troubled economy, businesses are looking for every possible way to cut costs. By engaging employees, companies can spark innovative changes in everyday business processes that save money and reduce environmental and social impacts while also inspiring employees to make sustainable choices at home and in their communities. And yet, many companies are not entirely sure how to effectively educate and involve employees in corporate environmental activities.

In response to growing interest in this timely topic, NEEF has researched the issue, conducted a survey of more than 1,300 professionals interested in business and environmental issues and documented eight case studies to gauge how leading companies approach internal environment and sustainability<sup>1</sup> (E&S) employee education and engagement. Some of the key findings are presented below.

### Environment & Sustainability Knowledge Valuable

- NEEF's survey reveals that **65 percent** of respondents value job candidates' E&S knowledge, while **78 percent** of respondents believe that the value of job candidates' E&S knowledge will increase in importance as a hiring factor within five years.

### Environment & Sustainability Education a Growing Trend

- Companies are not only anticipating that the value of E&S knowledge will increase, many are already providing some education to their employees about these topics. **Seventy-five percent** of companies educate employees about corporate E&S goals and **56 percent** of the respondents believe that their company has an advanced or very advanced E&S education program. The survey also indicated that many companies without an E&S education program are likely to adopt one soon. Nearly half (**49 percent**) of respondents whose companies have no program believe their company will begin educating employees in the next two years.

### Program Approaches Vary

- The survey also provided insights into the operational aspects of employee E&S education. The office responsible for E&S education varies among companies. Most companies cover a variety of environmental topics when communicating with employees. The most common topics include general E&S information and actions at work that can conserve or protect resources. According to survey respondents, the most important motivating factors for employees are concern for the environment and society, support or a mandate from the CEO, company reputation and job satisfaction. Despite the strong value placed on E&S education, companies indicated that they face several challenges when engaging employees, including lack of money, time, resources and executive support. The survey also indicates that companies were eager for tools to help them implement an E&S education program.

<sup>1</sup> While our primary focus is on environmental education, some companies include the environment as part of a broader sustainability or corporate social responsibility agenda. Thus, in this report, we use the term environment and sustainability or E&S.



In addition to the survey, case studies of Cisco, Clean Clothes, Inc. (Maggie's Organics), Hewlett-Packard Company (HP), Interface, Johnson & Johnson, Stonyfield, The Accessory Corporation and Wal-Mart provide an in-depth look at formal and informal employee educational methods and programs among companies of varying sizes in different sectors. The case studies provide additional context to the survey results by documenting best practices, highlighting lessons learned and examining measures of success.

## Common Themes in E&S Education

The survey and case studies confirm both the growing interest in and need for employee E&S education. They also reveal that there is no single formula for success, as internal employee education approaches vary widely from company to company. Despite the variety, the survey and case studies revealed common themes among companies with successful E&S education programs.

For several companies with effective E&S education programs, employee education is part of the companies' culture, often beginning with the hiring process, as in the case of Clean Clothes, Inc. and Interface. Successful programs often tie the education program to the company's mission and goals and performance evaluation processes. Most of the companies studied stressed the importance of involving all employees in a personal way. For example, Wal-Mart tailors information and makes it relevant to employees' personal lives as well as their jobs. Companies including Stonyfield also emphasized that measuring E&S performance is critical to driving progress, and as an education tool.

The case studies captured a variety of organizational models for the employee education programs. In part, this reflects the diversity of the cultures of the companies studied: while Cisco employees live and work in a Web 2.0 world and are comfortable collaborating online, Wal-Mart finds a person-to-person approach the most practical and effective. It also reflects varying purposes for the education programs. Some companies, such as Johnson & Johnson, aim to raise environmental literacy among their employees so they can contribute to environmental improvements both at work and in the community. Stonyfield educates and engages employees to meet specific goals in their areas of greatest environmental impact. Other companies, such as Interface, seek to leverage employees' knowledge and expertise to transform the company and its products and services to meet a sustainability vision.

The organizations used a varied, creative set of methods to reach and influence employees including multi-departmental leadership, employee-led "green" teams, awards, online training, mixed-media communications and performance incentives (see Figure 18: Case study matrix, pg. 14). In addition, several companies worked with external partners including non-governmental organizations (NGOs) to create successful E&S education programs, as in the case of Johnson & Johnson. Companies often used more than one organizational model for structuring their E&S education efforts, and the efforts extended beyond employees to include suppliers and customers.

## Challenges and Needs

Companies also face challenges when engaging employees in sustainability-related initiatives. The survey and case study findings highlight six general needs related to E&S education:

1. Many companies cited the need for education tools to help them implement an E&S education program, including case studies, success stories and training materials.
2. Companies repeatedly stated the desire for general, as well as job-specific, educational information to raise environmental awareness and for information related to the business case for E&S education.





3. There also appears to be a need for credible third-party partners to help companies develop training materials, as well as to make the business case for E&S education.
4. Many companies were interested in learning how to reach out to employees who were not already interested in the environment or sustainability issues.
5. A frequently cited concern was the need for appropriate indicators for measuring the impact of E&S education, beyond anecdotes.
6. Forums for identifying and sharing models and best practices related to E&S education are lacking.



**While environmental management used to be the province of specialists, responding to environmental challenges is now so fundamental to a company's success that environmental knowledge cannot be isolated within an organization, but must be pervasive.**



## Introduction

Companies both large and small are learning that sustainable business practices not only help the environment but also can improve profitability by supporting greater efficiency, less waste, less liability exposure, better community relations and more. In other words, good environmental and social stewardship is now moving front and center into fundamental business strategies.

Unfortunately, many companies are still missing a vital opportunity to realize these objectives: they have yet to engage fully their most powerful resource — their employees. Every day, employees across an organization make decisions with far-reaching environmental and social consequences. Informed decisions about such straightforward matters as procuring a corporate vehicle fleet, programming heating and cooling systems, adjusting energy settings on computers, commuting to work, even purchasing paper, printers or kitchen equipment can reduce a company's carbon footprint — *and* save money.

In response to growing interest, The National Environmental Education Foundation (NEEF) has done research on this issue and conducted a survey to gauge how leading companies approach internal employee education and engagement.

The survey is part of a larger study on corporate environmental and sustainability education. Through case studies, the study documents best practices, highlights lessons learned and examines measures of success. For our audience of business executives and managers, we hope that these elements will begin to define viable, practical strategies to engage employees on a range of in-house environmental and sustainability matters.

The goal of NEEF's Business and Environment program is to help organizations engage their employees directly to understand how their actions can contribute to achieving environmentally superior performance. By doing so, companies can spark innovative changes in everyday business processes that both save money and reduce environmental and social impacts as well as inspire employees to make sustainable choices at home and in their communities. The starting point is in each company's own corporate culture; engaging employees in bringing to life the company's values and commitments to sustainability.



**Corporate environmental education and sustainability programs are frequently launched with great enthusiasm yet often lack structure, quantifiable cost savings and accountability to guarantee success. Programs fizzle when they do not gain executive sponsorship or gather user feedback, interaction and participation from employees and customers alike. NEEF's efforts to inform companies of the importance of aligning sustainability programs and efforts with business goals will prove crucial in reaching corporate triple bottom line objectives.**

**– Christopher Spain, chairman and chief strategy officer of HydroPoint Data Systems, Inc.**



## Survey Findings

The NEEF survey, conducted in May 2008, examines aspects of corporate environmental and sustainability education initiatives at companies at varying stages of program development defined as: advanced, beginner, no program yet and no program in future.<sup>2</sup> There were 1,354 survey respondents, with approximately 300 respondents per level. However, not all respondents answered every question.<sup>3</sup>

The results represent a purposeful sample of those interested in business and environmental issues. More than 87 percent of those taking the survey represented businesses (Figure 1). Respondents were a mix of mainstream, environmentally progressive large companies and small “green” companies.

Survey participants were recruited from a number of sources. Most of the non-business and small-business respondents are from the GreenBuzz mailing list, which has a broad audience beyond corporate employees, and the Co-op America mailing list, which also includes many small green businesses.<sup>4</sup> Thus, the small business survey participants may not represent typical small businesses, but rather an interesting and rapidly growing segment of the business community.

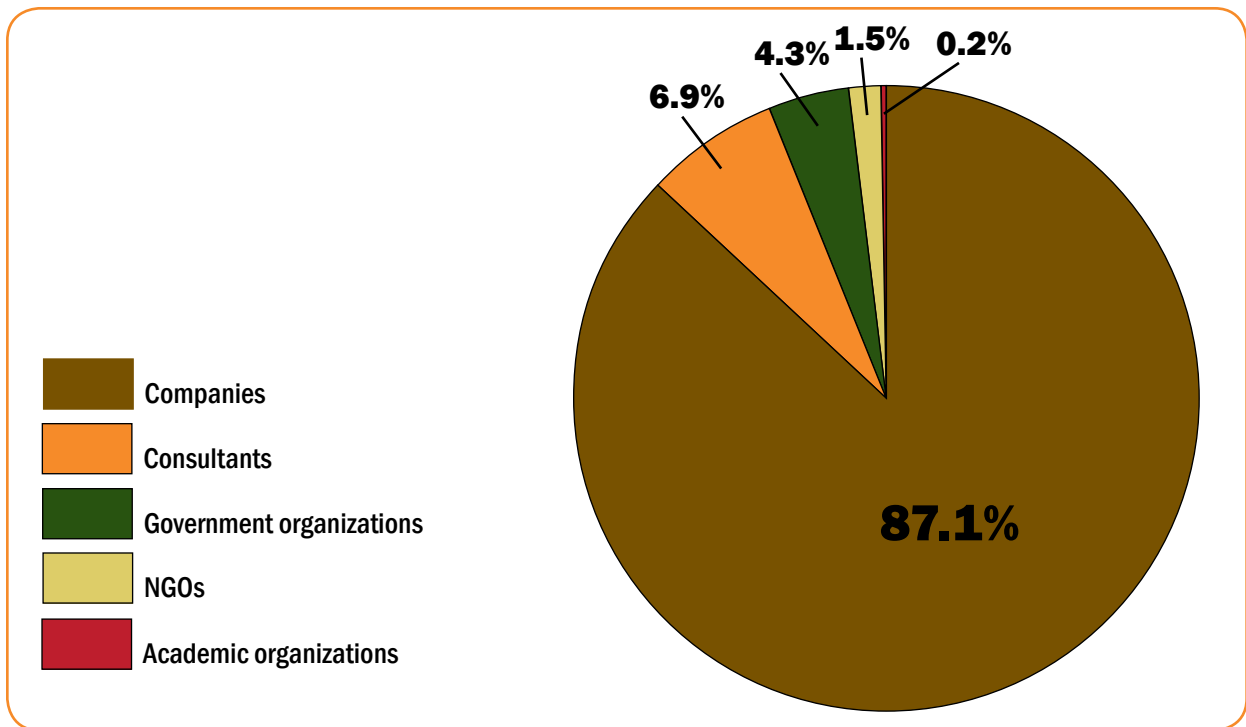

**Figure 1: Overview of survey respondents**

<sup>2</sup> In the survey, education programs levels are defined as:

- Very advanced (High level of employee awareness that supports aligned values, strategy and operations);
- Advanced (High employee awareness and engagement, but some areas still need improvement);
- Improving (Some employee awareness is evident, but still need to change company culture and employee behavior);
- Taking first steps (Exploring ways to achieve this).

For purposes of analysis the advanced stage includes respondents in the “very advanced” and “advanced” categories, the beginner stage includes respondents in the “improving” and “taking first steps” categories, the no program yet/in future stage includes respondents who indicated that their company does not currently have and/or does not plan to have an E&S education program for their employees.

<sup>3</sup> The full survey can be found in Appendix A. A comprehensive set of survey findings can be found on NEEF’s website.

<sup>4</sup> GreenBiz ([www.greenbiz.com](http://www.greenbiz.com)) and Co-op America ([www.coopamerica.org](http://www.coopamerica.org)) distributed the NEEF Business and Environment Program Survey to their respective mailing lists.



## Participant Overview

Survey participants represented a broad range of industry sectors, with the greatest number of respondents from the consumer goods (19 percent) and energy (12 percent) sectors (Figure 2). In terms of size, 40 percent of respondents were from small companies (less than 99 employees), 40 percent were from medium companies (100 to 9,999 employees), and 20 percent were from large companies (more than 10,000 employees).<sup>5</sup>

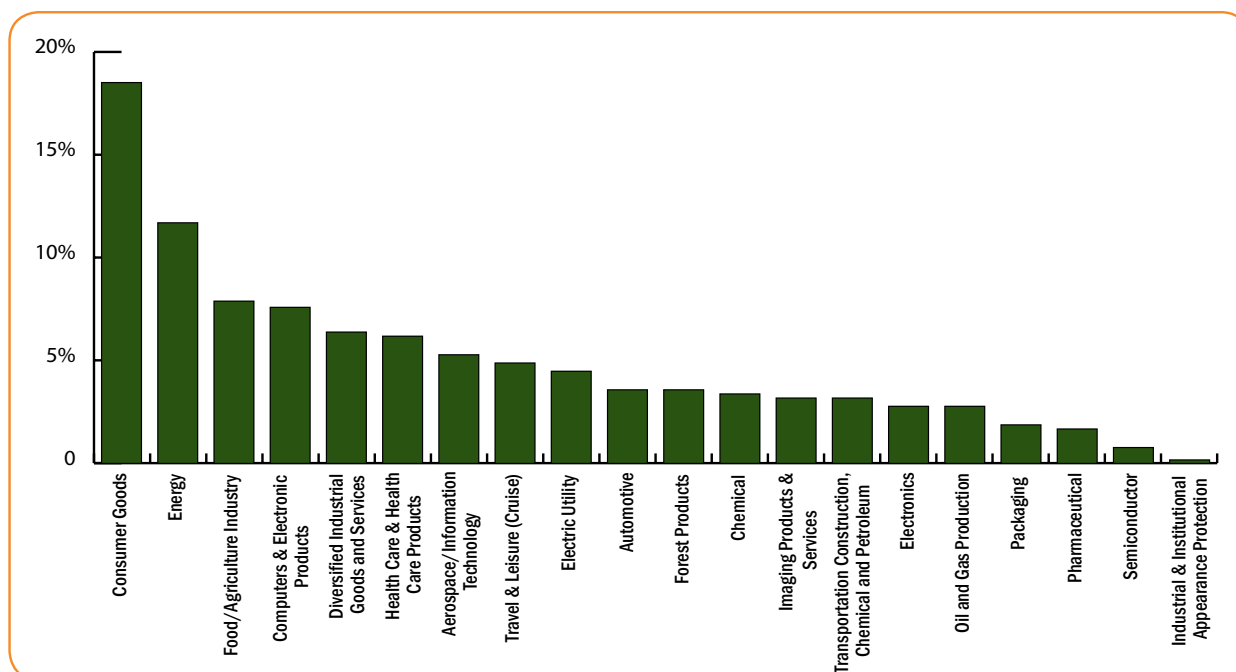

**Figure 2. Industry coverage by sector (n=1303)**

The survey indicated that “**sustainability**” is the term most often used (by 34 percent of respondents) to refer to environmental and sustainability (E&S) activities, with “greening” the next most prevalent (Figure 3).

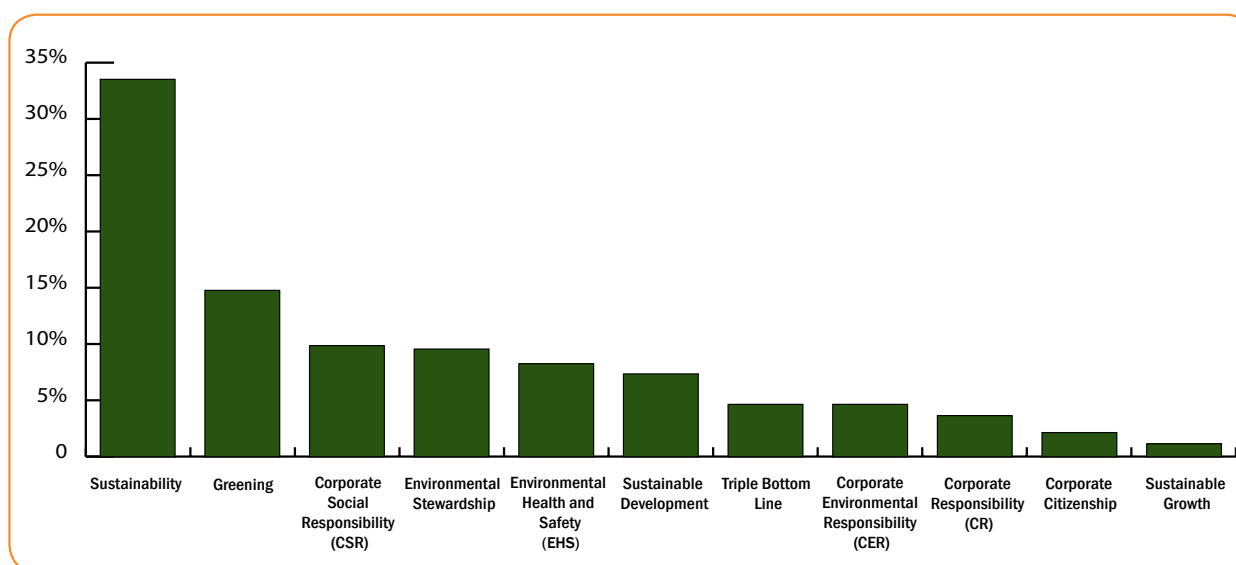

**Figure 3. Term used to describe environmental and sustainability activities (n=1018)**

<sup>5</sup> Not all respondents answered the question regarding company size; therefore results broken down by company size differ slightly from aggregate responses.





The small company respondents were more frequently located in marketing and sales or “other” functions, while large and medium company respondents were primarily marketing and sales, Environment, Health and Safety (EHS), facilities, Corporate Social Responsibility (CSR) and “other” functions (Figure 4).<sup>6</sup>

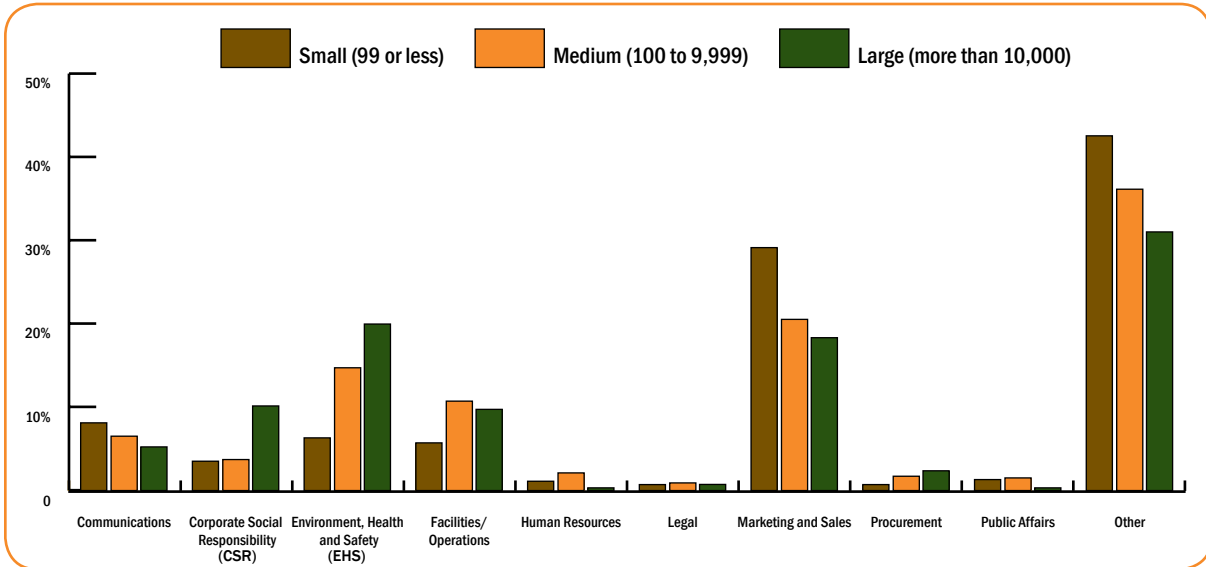

**Figure 4. Departments represented in the survey (n=1303)**

Respondents from small companies were primarily president, owner or CEO, while large and medium company respondents were primarily manager or staff-level (Figure 5).

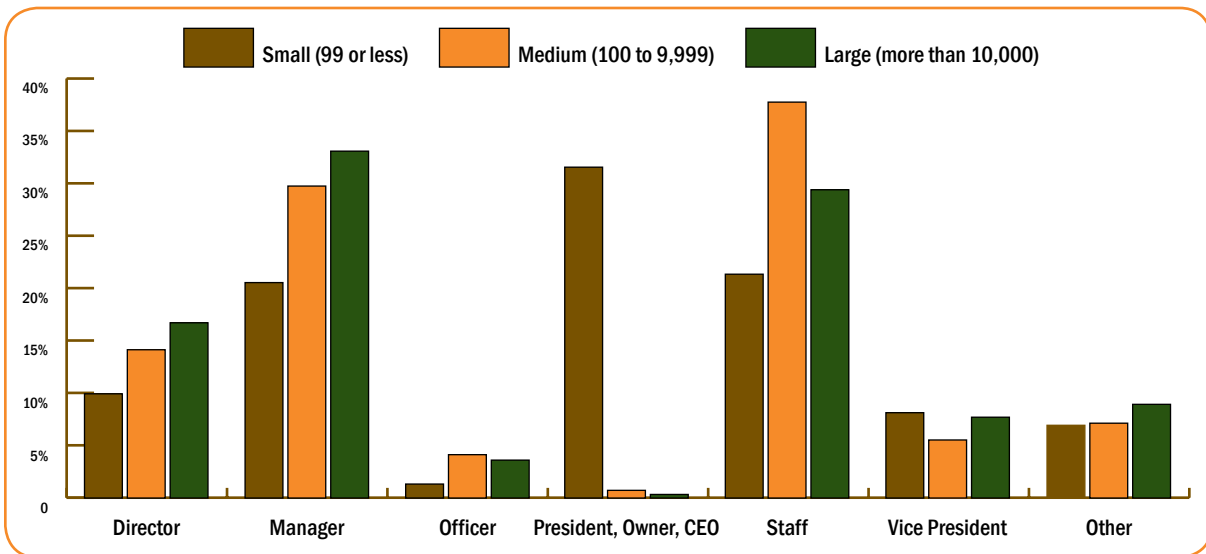

**Figure 5. Respondent positions (n=1307)**

<sup>6</sup> Respondents from the “other” category include: sustainability office, strategic planning office, engineering, research, finance, consulting and professor.



## Environment and Sustainability Knowledge

The survey indicated that E&S knowledge is both valued by companies and is expected to increase in importance as a hiring factor. Currently, **65 percent** of respondents value job candidates' E&S knowledge, but the percentage of companies placing at least some value on E&S knowledge is higher at small companies (71 percent) than at medium (57 percent) or large (46 percent) companies (Figure 6).

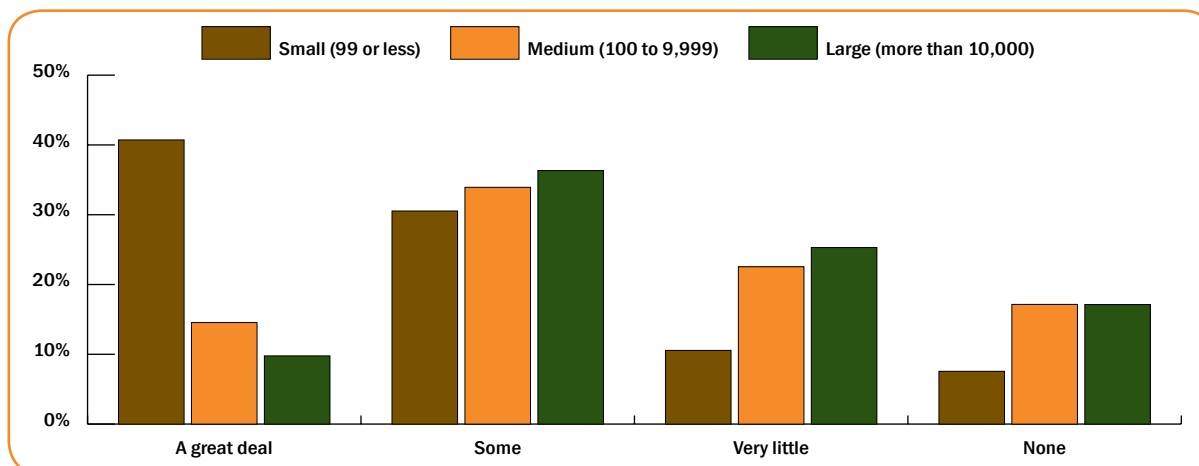

**Figure 6. Value of E&S knowledge (n=1112)**

A high percentage (**78 percent**) of respondents believe that the value of job candidates' E&S knowledge will increase in importance as a hiring factor within the next five years, with 75 percent of small, 64 percent of medium and 67 percent of large company respondents agreeing with that prediction. Virtually no respondents expect it to decrease (Figure 7).

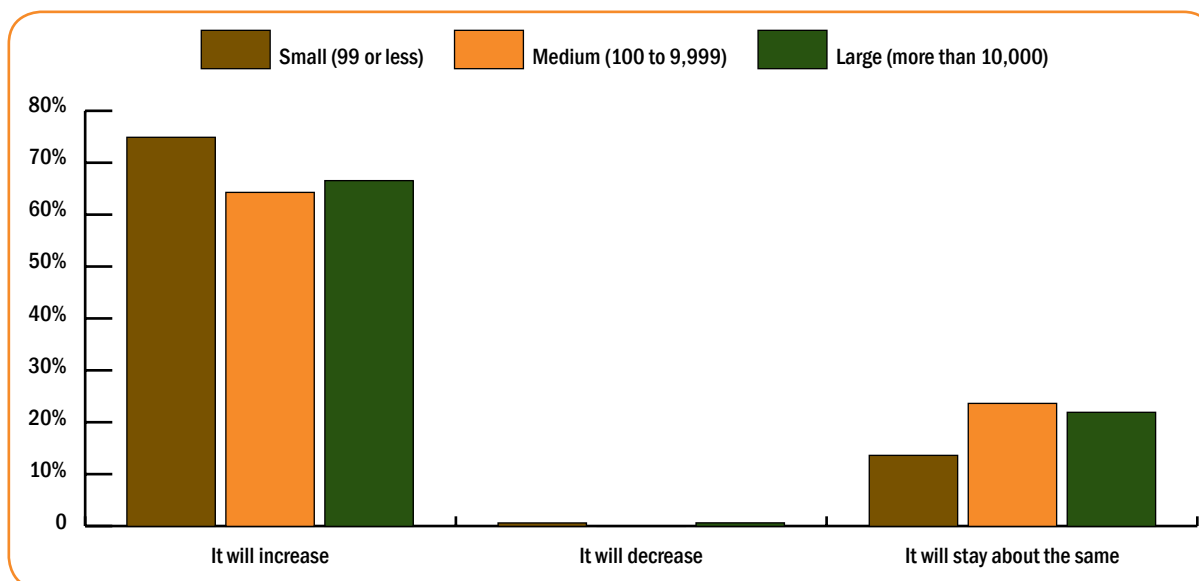

**Figure 7. E&S knowledge as a hiring factor (n=1114)**



## Environment and Sustainability Education

Companies are not only anticipating that the value of E&S knowledge will increase, they are already doing something about it. For example, **75 percent** of companies educate employees about corporate E&S goals.

More than half (**56 percent**) of the respondents believe that their company has an advanced or very advanced E&S education program. Among small company respondents, 51 percent believe that their company has an advanced or very advanced E&S education program, compared to 29 percent and 30 percent of medium and large companies respectively (Figure 8).

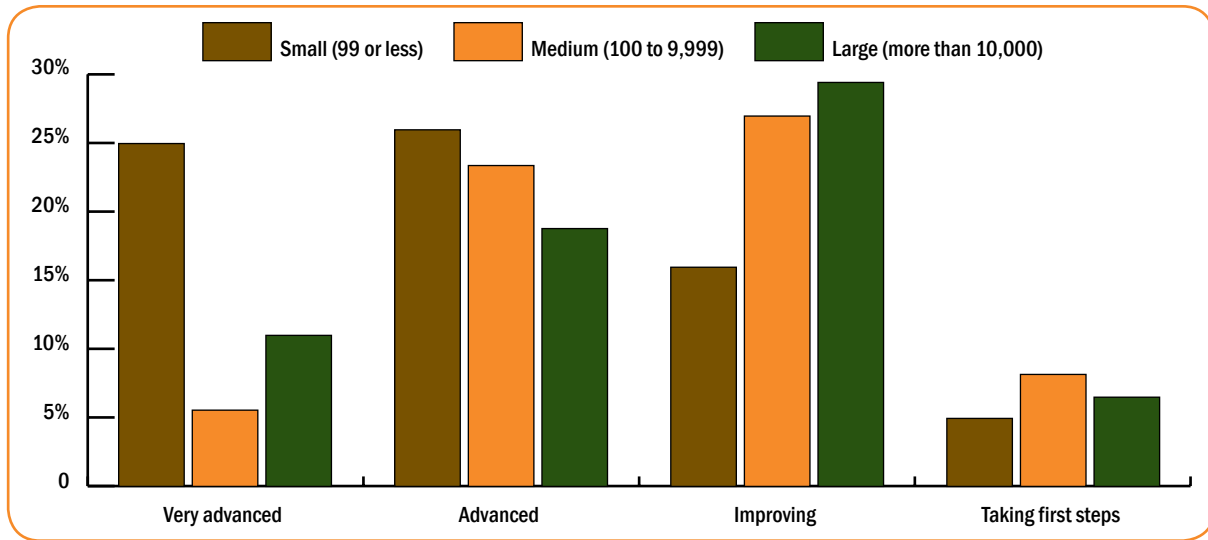

Figure 8. Corporate E&S education programs (n=871)

## Trends in Environment and Sustainability Education

The survey indicates that companies lacking an E&S education program are likely to adopt one soon. Nearly half (**49 percent**) of the respondents whose companies have no program yet believe their company will begin educating employees within the next two years (including 14 percent of small and medium and 12 percent of large company respondents) (Figure 9). Only about 10 percent of respondents do not expect to start a program, citing as reasons competing priorities, lack of time and lack of goals.

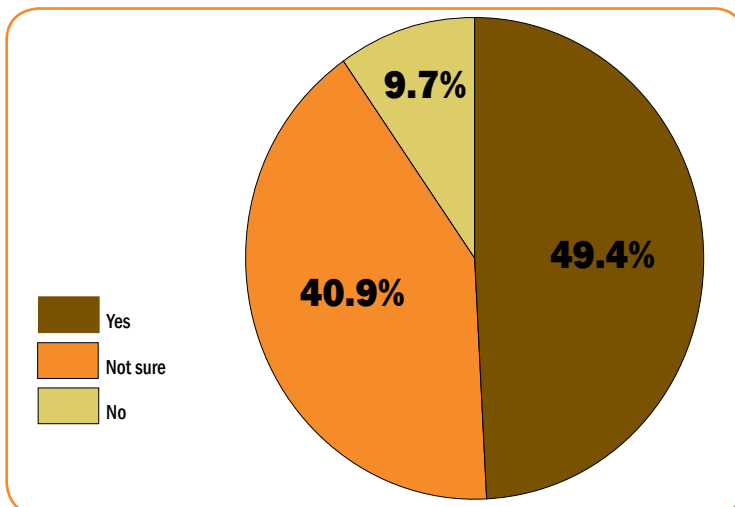

Figure 9. Companies expecting to adopt an E&S education program (n=1004)



## The Mechanics of Environment and Sustainability Education

Results of the survey indicate that the function responsible for E&S education varies with the educational program level. In general, companies with **advanced programs** house E&S education in the corporate social responsibility or environmental health and safety offices (Figure 10). Many **beginners** also include E&S education in the responsibilities of the CSR and EHS offices, but some also rely on the Marketing and Sales office (Figure 11). Marketing and Sales is the key department responsible (or anticipated to be responsible) for environmental education in **small companies and those with no program**.

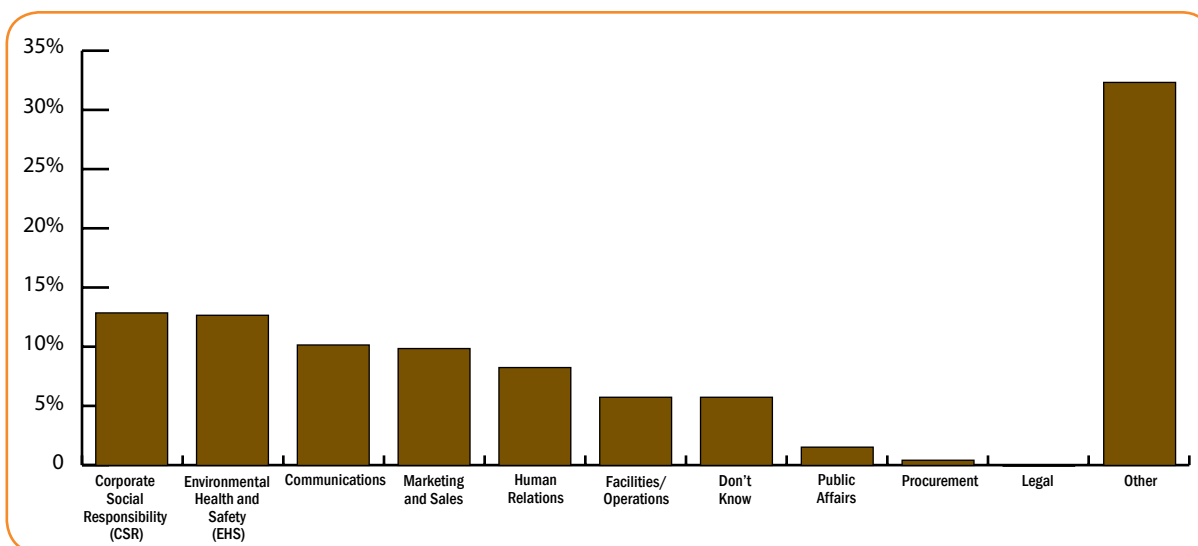

Figure 10. Departments responsible for advanced programs (n=433)

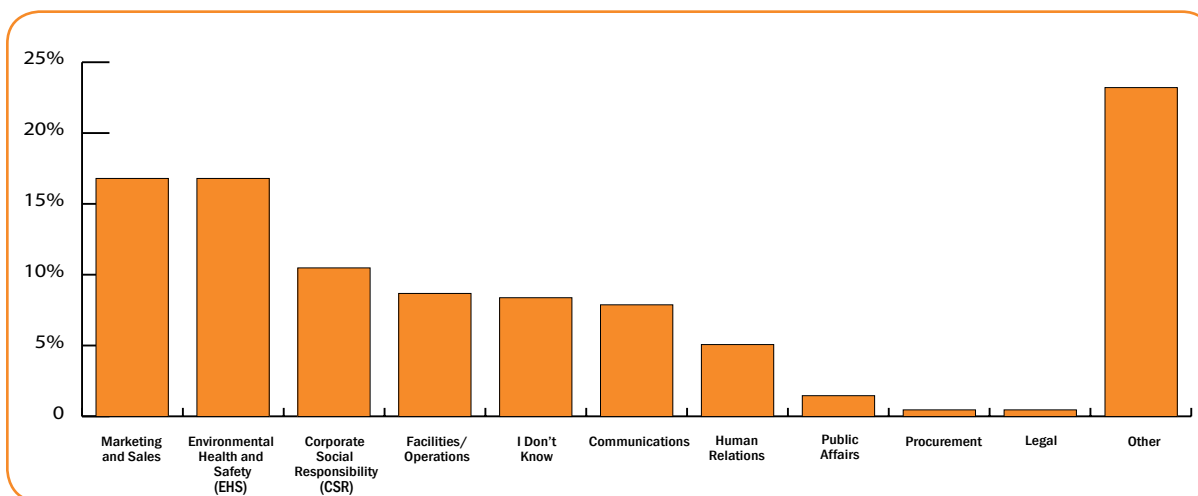
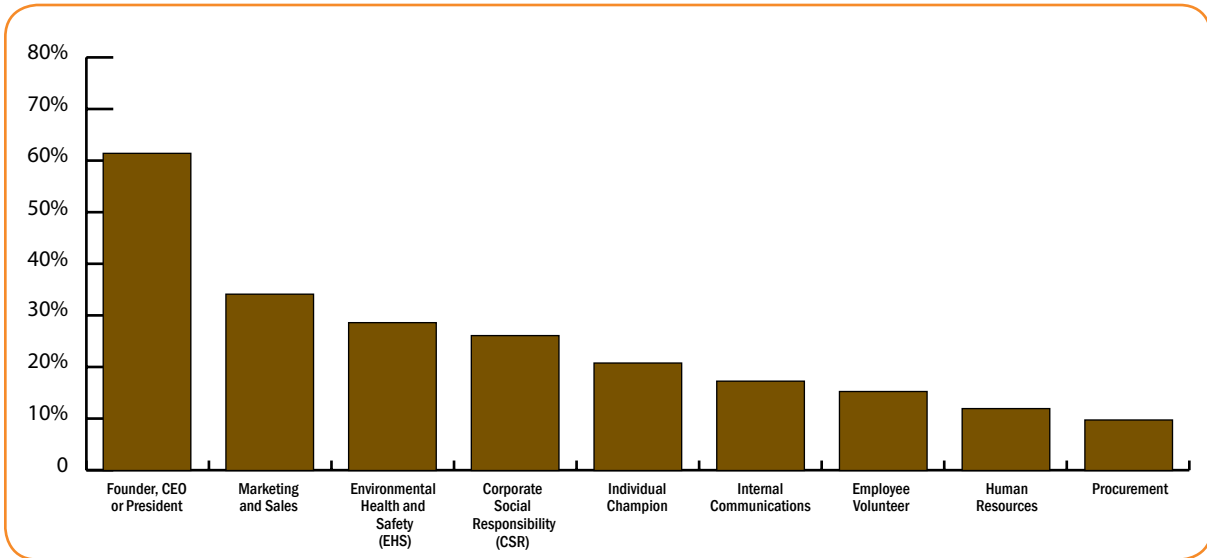

Figure 11. Departments responsible for beginner programs (n=392)



For companies with advanced programs, the founder, CEO or president is most often the champion of E&S education (Figure 12). In most companies with beginner programs, the marketing staff champion E&S education, followed by the founder, CEO or president and EHS staff (Figure 13).



**Figure 12. Company champions for advanced programs (n=363)**

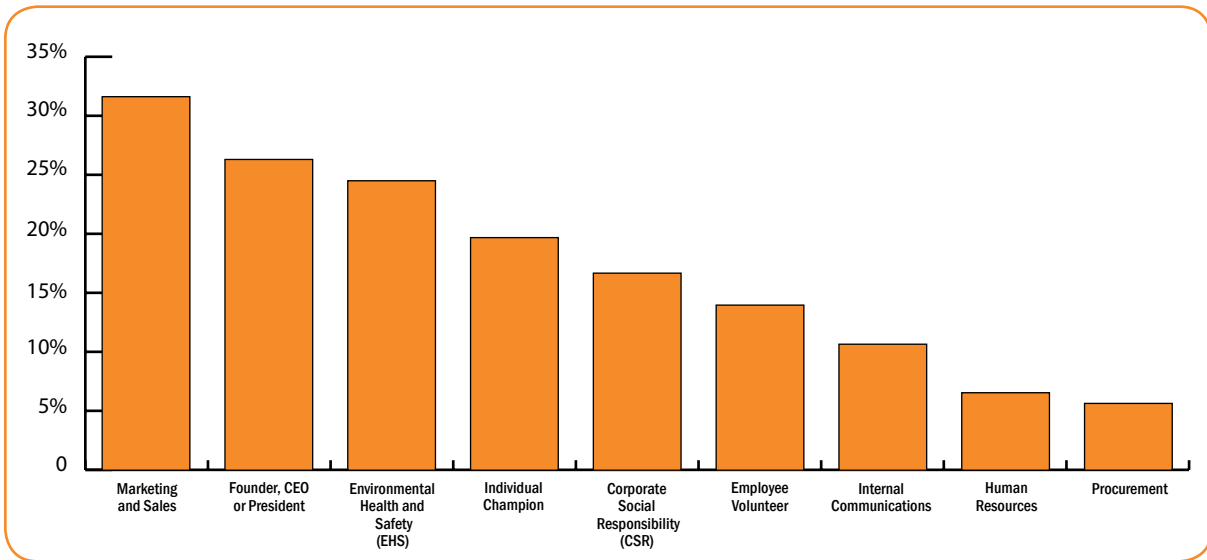

**Figure 13. Company champions for beginner programs (n=335)**





Companies at all program levels cover a variety of environmental topics when communicating with employees; the most common topics include general E&S information and actions employees can take at work to conserve or protect resources. Four additional topics related to a company's environmental impacts and actions scored highly: environmental footprint, company efforts to conserve and protect resources, environmental success stories and E&S attributes of products and services (Figure 14).

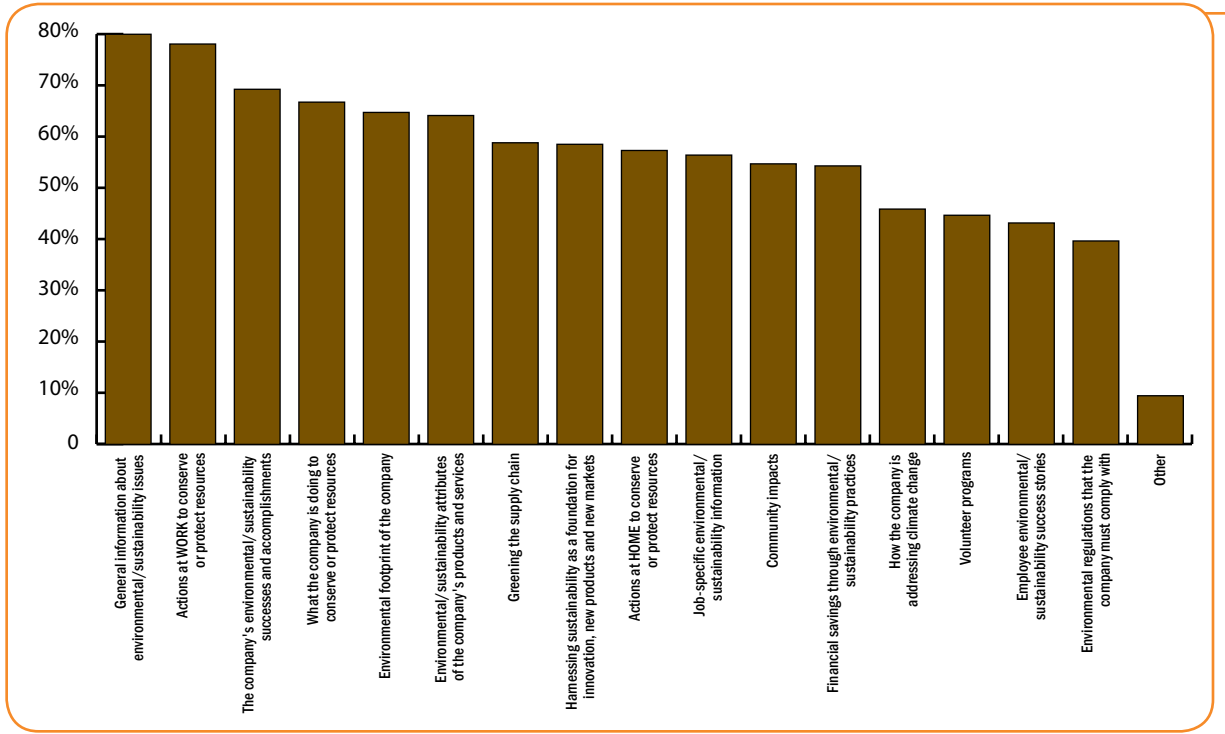

Figure 14. Topics covered by companies with advanced programs (n=468)

Respondents in the advanced program level use a variety of education methods. These respondents find online training modules to be most effective, followed closely by hiring a consultant and competitions (Figure 15).

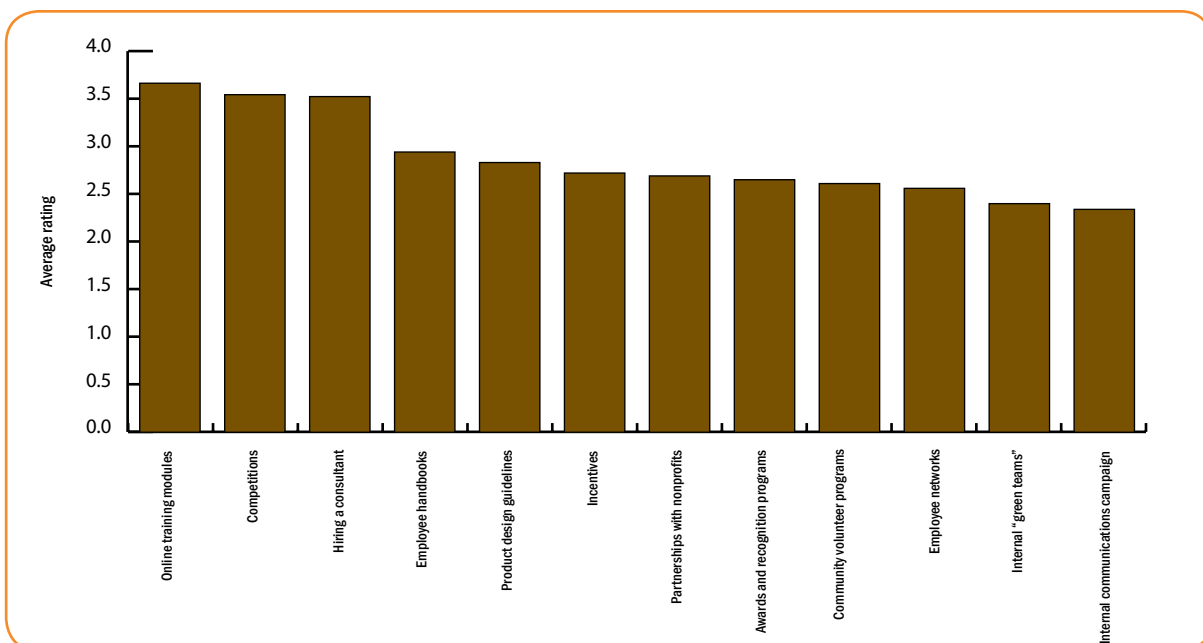

Figure 15. Education methods used by companies with advanced programs (n=420)



## Employee Resources and Training Material at IKEA

### IKEA

Revenue: \$28.6 billion

Number of Employees: 118,000

Headquarters: Leiden, South Holland, The Netherlands

Industry: Consumer products retail

All IKEA stores are required to have an environmental coordinator (EC) and an action plan for recycling, waste sorting, energy saving, transport of goods and education. The ECs receive key performance indicators (KPIs) from the central office and then set goals. The ECs often focus on operational improvements, sharing best practices and community activities (engaging local customers).

IKEA offers online and classroom training focusing on “must know” and “good to know” material. The former includes company background, the corporate sustainability direction, why the employees are receiving the training, information on global environmental issues (e.g., climate change), areas the company needs to focus on, the EC and committee structure and recycling and environmental management, along with practical examples. The “good to know” category includes topics such as procurement standards, the company’s approach to forestry, partnerships and social projects on a global level.

For companies at the **advanced and beginner program levels**, respondents report that the most important factors motivating employees to incorporate environmental dimensions into their job are: concern for the environment and society, CEO support or mandate, company reputation and job satisfaction (Figures 16 and 17).

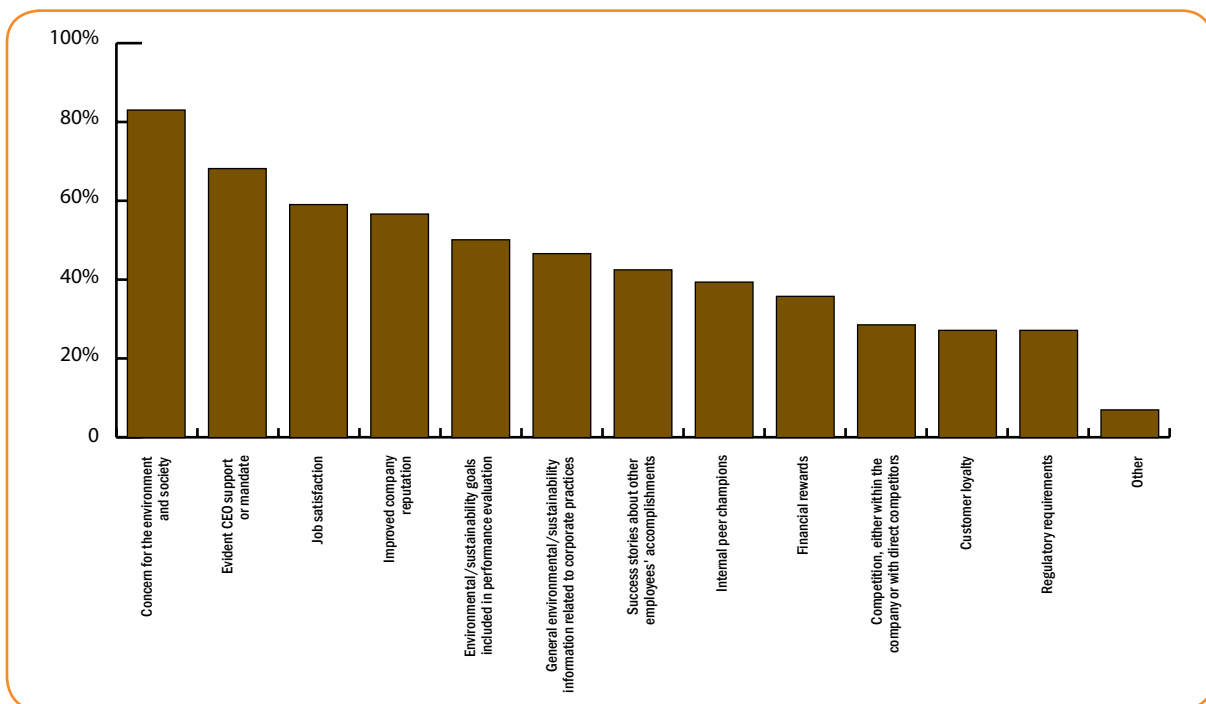

Figure 16. Motivating factors for companies with advanced programs (n=418)

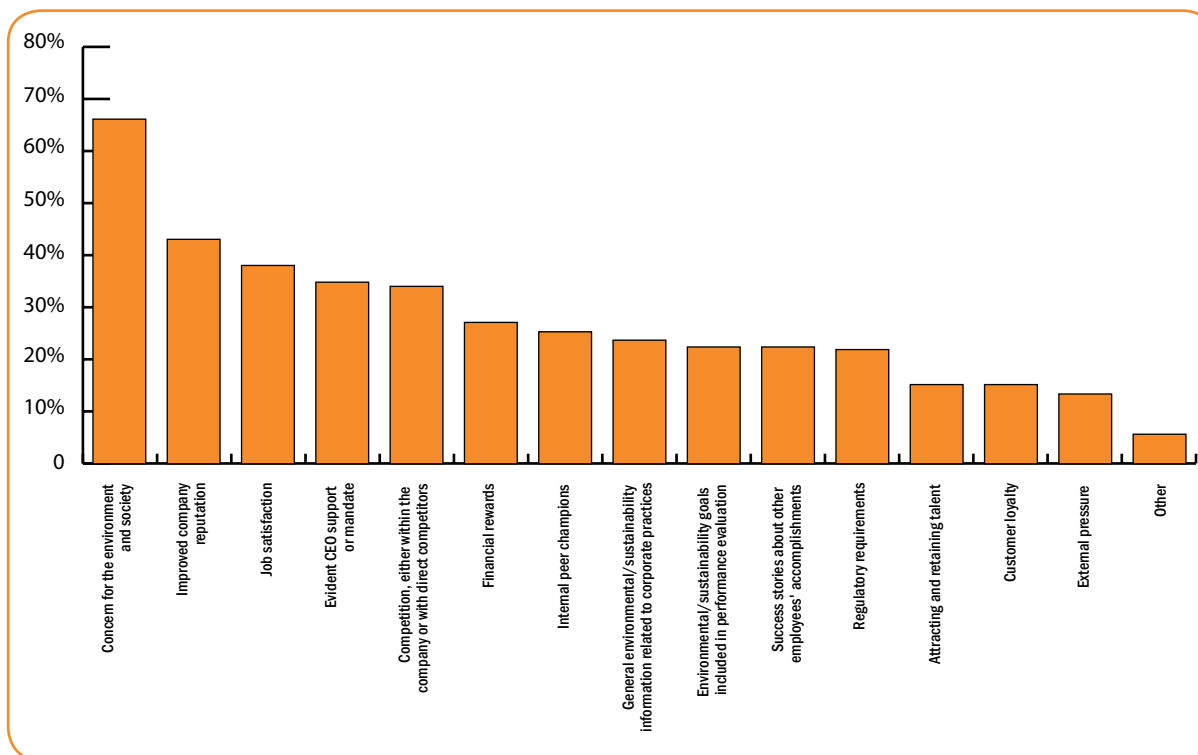

Figure 17. Motivating factors for companies with beginner programs (n=378)

## Hurdles

Despite the strong value placed on E&S education, companies indicate that they face several challenges when engaging employees. The primary themes among all respondents were the **lack of money, time, resources and executive support**. Companies in the beginner track stress a **lack of knowledge** as well. Large companies stress the difficulty of **culture change** within the company more frequently.

## Tools

The survey results indicate that companies are eager for tools to help them implement an E&S education program. In an open-ended question, respondents repeatedly state the need for tools including **case studies and success stories, training materials and funds**.

## Education Topics and Methods at BT

### BT (formerly British Telecom)

Revenue: \$3.27 billion

Employees: 104,399

Headquarters: London, England, UK

Industry: Telecommunications

BT's "Great Switch Off" campaign aims to raise awareness around energy use and climate change by encouraging people to turn off computers and lights around the company. BT advertises the event with emails and posters around the company in the cafeteria, coffee rooms, etc. Floor captains volunteer to audit electronics and office lighting then follow up with a second audit in a month. Floor captains leave stickers if computers were left on standby and lights are left on. Items left on standby decreased by 20 percent over the month during the first "Great Switch Off." Champions and floors with the greatest reduction receive a gift.



Companies both large and small are learning that sustainable business practices not only help the environment but also can improve profitability by supporting greater efficiency, less waste, less liability exposure and better community relations. In other words, good environmental and social stewardship is now moving front and center into fundamental business strategies.



## Case Studies: Learning from Leaders

NEEF conducted case study interviews from June through November 2008, to document best practices in E&S education, highlight lessons learned and examine measures of success. As a complement to the survey findings, the case studies are meant to provide additional insights to help business managers define viable, practical strategies to engage employees on a range of in-house environmental and sustainability matters.

Case studies presented in this report are grouped by the size of the company and include:

### *Large Companies*

- Cisco Systems, Inc.
- Hewlett-Packard Company (HP)
- Interface, Inc.
- Johnson & Johnson, Inc.
- Wal-Mart, Inc.

### *Medium Companies*

- Stonyfield, Inc.
- The Accessory Corporation, Inc.

### *Small Company*

- Clean Clothes, Inc. (Maggie's Organics)

## Methodology

As a first step in selecting company programs to document in the case studies, we completed an extensive review of company reports and external rating and rankings. We then developed brief profiles of nearly 20 companies based on the review. The profiles included descriptions of the companies and their environmental education and engagement practices. Subsequently, Business Program Advisory Committee members selected eight companies to feature as case studies representing a variety of educational models, company sizes and industries/sectors. All companies selected as case studies represent examples of effective, established employee environmental educational programs. The case studies were completed via in-depth interviews, as well as a review of company reports, documents and websites. The case studies in this report are presented as told by company representatives, and in some cases several representatives, from a variety of departments.







**Figure 18. Case study E&S education program highlights**

<b>Company</b>	<b>Synopsis</b>	<b>Organizational Method</b>	<b>Responsible Department</b>	<b>Audience</b>
<b>Cisco</b>	Cisco has identified environmental sustainability as a global corporate priority. One of the company's supporting initiatives is to inspire employees to get involved and to take action. Through the use of Web 2.0 technologies such as a dedicated intranet Web site, video, and discussion forums, the company engages employees in environmental management programs and an annual worldwide environmental awareness campaign.	Mixed-media communications; multi-departmental leadership	Internal Communications	All employees
<b>Clean Clothes, Inc. (Maggie's Organics)</b>	Maggie's does not have a formal environmental education or training program; at Maggie's, environmental education is integrally connected to the product. The company works with business partners to improve environmental practices. It also screens new employees for their knowledge about organics and organic cotton. As a result, the corporate culture attracts employees who are environmentally aware.	Informal; employee-led "green teams"	Owner driven; No single responsible department	All employees; Suppliers
<b>Hewlett-Packard</b>	HP provides employee environmental education through mixed-media communications, events and programs. For example, HP provides employees with brown-bag informational seminars about installing solar roofs at their own homes, and incentives for employees using solar energy. HP also supports grassroots employee sustainability networking.	Mixed-media communications; employee-led "green teams"; incentives	Corporate Environmental Sustainability Group	All employees
<b>Interface</b>	Interface is on a mission to have zero environmental footprint by 2020. To realize this mission, it has made sustainability part of every employee's job. Interface uses several educational practices including job-appropriate training, storytelling and learning modules to support employee learning and development.	Online training; performance incentives; awards	All employees	All employees
<b>Johnson &amp; Johnson</b>	Johnson & Johnson set a goal to improve environmental literacy among its employees by 2010. Within the first year, 92 percent of Johnson & Johnson's facilities had an environmental literacy plan, and 79 percent of facilities had deployed an annual environmental literacy module.	Mixed-media communications; multi-departmental leadership	Corporate EHS office	Corporate staff; Facilities employees
<b>Stonyfield</b>	At Stonyfield, employee engagement and education on E&S issues begins with the hiring process. Then Stonyfield's Mission Action Plan (MAP) engages all employees in its sustainability mission by linking long-term environmental impact goals to job performance measures.	Multi-departmental leadership; employee-led "green teams"; mixed-media communications; performance incentives	MAP team employees (designated by impact area)	All employees
<b>The Accessory Corporation (TAC)</b>	TAC's E&S education journey began with attendance of top management at an in-person training seminar supported by one of their major customers. The managers took the information back to TAC and shared it with other employees. As a result, TAC developed a new hanger design using renewable material and a re-use program.	Informal; multi-departmental leadership	Marketing	All employees; major retailers
<b>Wal-Mart</b>	Wal-Mart, the world's largest retailer, has the size and scope to influence change throughout the industry. Wal-Mart believes that its associates are critical in the company's efforts to become a more sustainable business. Its Personal Sustainability Project (PSP) has engaged more than 500,000 associates voluntarily in its sustainability efforts, demonstrating measurable results in associates' lives and in the workplace. Additionally, Wal-Mart's Sustainable Value Networks engage salaried associates, and all salaried associates' performance evaluations include a question on the associates' contribution to sustainability.	Employee-led "green teams"; multi-departmental leadership; mixed-media communications; performance incentives	Sustainability office	Corporate staff and associates



Purpose	Employee Motivation	Topics	Metrics	Key Lessons
Achieving goal of greenhouse gas emissions reduction; Supporting senior management vision	Saves money, fits within company goals, improves employee understanding of the company's green products	Energy, recycling, water bottles, biking to work	Website tracking; employee survey	Start with senior management vision; Nurture a green culture through customizable events and communications; Inspire employee conversation with one another; Use web 2.0 technology as an asset to provide employees with resources; Communicate green programs with employees first
Product innovation	Corporate culture attracts employees who are environmentally aware	Environmentally friendly materials; packaging; practices for apparel production	N/A	Embed sustainability in your culture and product; Foster a culture of learning; Use credible third-party information to make the case for environmental improvements; Use credible third-party information to make the case for environmental improvements; Influence the supply chain through education and dialogue; Make the business case internally and with business partners
Raise awareness about the availability of green products, services and events	Concern for the environment	General environmental awareness; solar energy	Webcast attendees and recorded viewings, the number of employees attending events, the number of subscriptions to receive environmental tips via email, the number of pledges received and the estimated carbon reductions resulting from the pledges	Support grassroots efforts with a variety of resources; Use a combination of media for communications, events and programs; Incentivize employees' actions at home; Measure results; Reach out to the less motivated
Product innovation; Achieving goal of zero impact	Corporate culture attracts employees who are environmentally aware; CEO mandate		Employee engagement per Gallup poll; Materials usage	Make E&S part of a shared vision and the company culture, not a "flavor of the month"; Measures are critical, and the best teacher; Storytelling is a powerful tool; Include all employees; Consider E&S motivation and knowledge in the hiring process
General awareness; Product innovation	Varies	Sustainability goals; sustainability; forestry; climate change	Number of facilities with literacy plans and deploying literacy modules	Build on existing company culture; Tailor the messages for the audiences; Use repeated, frequent messaging and multiple media; It's okay to go after employees' hearts; work with partners outside the company
Reducing environmental impact of production	Job accountability and bonuses	Key sustainability impact areas	Reduction of environmental impact in 11 key areas	Tie E&S education to the company's mission and goals; Focus on key impact areas and set improvement goals; Make E&S relevant to job performance; Assess E&S knowledge and motivation part of the hiring process
Product innovation; Reducing environmental impact; Customer mandate	Customer mandate	Environmentally friendly materials; packaging; reuse	Packaging reduction	Retailer support is key; Include all functions in the search for solutions; Persistence
Employee engagement to achieve sustainability goals	Personal, voluntary commitments	General sustainability awareness	Number of employees who adopt a PSP, the type of PSP and employees' success/ impact in aggregate	Make E&S outreach personal and voluntary; Grassroots and personal involvement is essential; Engage employees in setting goals



## Nurturing a Green Culture

### Case Study: Cisco Systems, Inc.

#### Company profile:

**Company:** Cisco Systems, Inc.

**Industry:** Information/Communications Technology (ICT)

**Headquarters:** San Jose, Calif.

**Number of Employees:** 66,050

**Total Revenue:** \$39.54 billion

#### Cisco's Story

*Kenis Dunne, senior manager, Internal Communications; Rob Rolfsen, director, Sustainable Development; Melanie Stevens, program manager, Internal Communication*

**Synopsis:** Cisco Systems, Inc. (Cisco) has identified environmental sustainability as a global corporate priority. One of the company's supporting initiatives is to inspire employees to get involved and to take action. Through the use of Web 2.0 technologies such as a dedicated intranet website, video and discussion forums, the company engages employees in environmental management programs and an annual worldwide environmental awareness campaign.

#### Why the program was started: Acceleration of a bold "green" vision

The Cisco culture of entrepreneurship, innovation and collaboration extends to the environmental arena. The company's bold vision is that if it can be connected to the Internet, it can be green. To help accelerate execution of this vision, the company established the Cisco EcoBoard in late 2006, made up of 14 leaders from across Cisco. The EcoBoard grew out of the commitment of a small group of employees who had formed a cross-functional team to address environmental concerns and opportunities.

Working in partnership with the EcoBoard is the Green Task Force (GTF), which is a strategic team that drives the execution of the Cisco "green" vision and strategy through long-term programs and initiatives throughout the company. The GTF reports to the EcoBoard and consists of directors and senior managers who provide cross-functional management, monitoring and coordination of environmental programs. The GTF, in turn, uses several working teams responsible for implementing targeted near-term green initiatives. The GTF

tactically manages the EcoBoard's goals and tracks them through an online dashboard hosted by the Quality organization. The GTF teams report progress toward goals on a quarterly basis and provide links and resources about the programs.

The EcoBoard's strategic initiatives focus on four areas:

- Sustainable company operations;
- Innovative customer solutions;
- Environmentally responsible product design, including the supply chain;
- Building awareness and inspiring employees to take action.

The first of these initiatives includes reducing emissions from business air travel by 10 percent based on a FY2006 baseline as well as reducing the company's absolute greenhouse gas emissions by 25 percent by CY2012 based on a CY2007 baseline.

The second and third initiatives are intended to help our customers achieve reductions. The information and communications technology (ICT) industry is responsible for only a small portion of the world's greenhouse gas emissions, but all industries share responsibility for solving the global-warming problem.

Part of the purpose of the EcoBoard's fourth strategic initiative is to inspire our employees to get involved and to take action. Our employees tell us that they want to be actively involved in the company's environmental strategy and execution plans. They have an impactful "everyday" role in the company's journey to reduce energy use and greenhouse gas emissions: we all can turn off lights, shut down lab equipment when not needed, choose to

#### Key Lessons:

- Start with senior management vision
- Nurture a green culture through customizable events and communications
- Inspire employee conversation with one another
- Use Web 2.0 technology as an asset to provide employees with resources
- Communicate green programs with employees first



use reusable dishware (versus to-go containers) in the cafeteria, print less, recycle more, and reduce travel by using our own collaboration tools.

For example, Cisco employees are at an advantage because the company produces solutions, such as Cisco TelePresence, that reduce the need for travel. Cisco actively encourages employees to think about alternatives before booking an airline ticket—the travel website reminds the employee of the remote collaboration options that are available in place of travel. Using the company’s own technology to reduce travel directly reduces expenses and the company’s environmental footprint, and makes employees experts on the use of their own products. (The Environmental Defense Fund recently recognized Cisco’s internal use of its TelePresence technology as a top “Business as Usual Innovation.”)

### **How the program works: Nurturing a green culture**

With our employees’ help, Cisco has made great strides internally toward environmental sustainability and execution of the EcoBoard’s vision. Cisco’s internal communications team aligns and maps to the EcoBoard’s environmental goals, and aims to increase employee awareness in a way that supports the EcoBoard’s goals and empowers employees to take action at work and in their own communities.

Each year, the team updates its plan to educate and engage employees on Cisco’s environmental sustainability programs. Companywide assets — an intranet Web site, video stories, bi-weekly green news stories and discussion forums for employees — are the foundation of the program. Each of these assets was created to inspire and educate employees, and to further the conversa-



tion on environmental topics among them. This clearly taps into our employees’ thirst for a lively exchange on the subject of “green” — the “Let’s Talk Cisco Green” discussion forum was the company’s top visited forum (with close to 62,000 views and 91 conversation threads) in the first six months.

Employees use these assets in a number of ways. In the discussion forum, for example, employees discuss where to recycle electronic waste and how to ease their commutes. They seek advice from colleagues and gauge their peers’ interest in initiatives such as a shuttle bus from San Francisco to San Jose, but they also offer suggestions for how Cisco can reduce its carbon footprint, save energy and reduce waste.

These assets support a variety of programs aimed at engaging employees in Cisco’s environmental vision. The two largest programs are ISO 14001, the environmental management program, and a worldwide environmental awareness campaign.







## Worldwide Environmental Awareness Campaign

Cisco annually hosts a Worldwide Environmental Awareness Campaign. The inaugural 2007 event increased employee awareness of environmental challenges and provided an opportunity to participate in global events such as eScrap collection, Earth Day, and Bike to Work Day.

Last year, the company expanded its take-back and recycle program for customers. It continues to encourage employees to participate in the twice-yearly E-Scrap events, where they can bring old electronics from home for recycling. During the 2008 E-Scrap collection, 53 Cisco sites worldwide collected nearly 327,000 pounds of unwanted personal and work electronic equipment.

The Earth Day 2008 events aimed to generate an overall positive experience for employees, reflecting well on Cisco and its commitment to its green programs. Forty sites in 20 countries participated. To encourage participation in Earth Day events, the corporate team provided local event coordinators with an email template for customization, a banner ad for intranet sites to publicize events, an EcoBoard welcome video that could be hosted locally, a customizable lobby and break room poster template, and Eco-Mobiles (a reusable hanging mobile shaped like a globe) for break rooms.

The bike-to-work event attracted nearly 900 participants from 40 sites in 13 countries. The corporate team provided participants with instructions on how to participate safely.

At headquarters in San Jose, Earth Day events attracted more than 2,300 attendees. Nearly 600 employees took the Water Challenge — more than half could not tell the difference between bottled and filtered water, part of a Cisco workplace campaign to replace water bottles with filtered-water systems. Other events included a Technology Showcase, EcoBoard and Green Task Force speakers as well as external speakers, and the presentation of four awards to Cisco for green programs. There were also numerous site-specific events around the globe.

In 2009, Cisco is introducing “Think Green, Act Green,” an internal activation campaign that asks Cisco employees to start with small acts of green in the workplace so that we can collectively yield big results.



## Measuring results: Employee surveys and website metric tracking

The internal communications team has completed two surveys, including random samples of all employees across the globe, to better understand employees’ awareness of environmental resources and their “relationship” with the internal Cisco green website. The surveys help to gauge whether the efforts are working and identify the “best bets” for allocation of communications resources going forward.

The team also tracks news stories and discussion forum usage every month to measure the amount of traffic and to learn more about how specific communications efforts (e.g., monthly recap e-letter, feature stories on the corporate homepage) affect traffic to the site. Earth Day programs had the most traffic last year, with discussion forum views jumping 87 percent (from about 63,000 to 119,000 views) from March to April.





## Next steps: Regional customization and consumer-facing information

The EcoBoard has spent the last two years laying the groundwork for the Cisco environmental vision. The company had the luxury of sharing its environmental vision first with employees, and developing the foundation with their help. As is its charter, the internal corporate communications team started with the internal corporate messaging and global employee information. With that in place, the team is beginning to partner with internal communications teams in other regions to provide customizable resources. The information is so much more relevant to employees if the stories and discussion forums are about their leaders and their local programs. Our team picks up regional stories and tells them globally and vice versa; it encourages stories to bubble up as much as possible.

Cisco is now beginning to see a pull from external audiences for environmental information, and internal communications has worked with Corporate Marketing as they created an externally facing green website. The internal stories will enhance external marketing. For example, the employee “Think Green, Act Green” campaign will have a “tell your friends and family” component that will bridge the internal campaign to one of the company’s successful public campaigns, “One Million Acts of Green.”

There are many more stories to tell that are of interest to both employees and customers — particularly those about customer products and solutions. Cisco has worked on the environmental vision quietly, and carefully considered how to back up goals with numbers and metrics.

### Links to More Information:

Sustainability in the Workplace at Cisco video  
[www.youtube.com/watch?v=nKw\\_ykrHfwM](http://www.youtube.com/watch?v=nKw_ykrHfwM)

Cisco on Environmental Sustainability  
[www.cisco.com/go/green](http://www.cisco.com/go/green)

Cisco Corporate Social Responsibility:  
[www.cisco.com/web/about/citizenship/index.html](http://www.cisco.com/web/about/citizenship/index.html)

Cisco Corporate Social Responsibility Report:  
[www.cisco.com/web/about/ac227/csr2008/index.html](http://www.cisco.com/web/about/ac227/csr2008/index.html)

One Million Acts of Green:  
[green.cbc.ca/](http://green.cbc.ca/)

## Tangible Results: Earth Day 2008 Campaign Around the Globe

“[Earth Day] got people talking, raised awareness and promoted other things that they can do after they leave work today” is just one of the many comments from participants of the *Cisco Celebrates the Environment—Earth Day 2008* campaign.

Many sites showcased hybrid vehicles and held farmers’ markets with locally grown organic food.

“The food was incredibly delicious,” said an employee of the farmers’ market lunch in Austin. “The event inspired me to seek out better produce and to maybe start my own organic herb garden.”

In India, booths were set up to distribute information about rainwater harvesting, solar heating panels and composting. The campus also had vehicle emissions test booths. Event organizers reported that the workplace resources booth was quite popular because employees are eager to know how the green initiative was to be carried out on the campus. Cisco India’s Earth Day efforts were also captured in the local newspapers.



## Living the Green Life

### Case Study: Hewlett-Packard Company

#### Company profile:

**Company:** Hewlett-Packard Company  
**Industry:** IT, Computer systems and software  
**Headquarters:** Palo Alto, Calif.  
**Number of Employees:** 309,000  
**Total Revenue:** \$104.3 billion

#### HP's Story

*Debbie Ledbetter, director, HP Environmental Sustainability*

**Synopsis:** Hewlett-Packard Company (HP) provides employee environmental education through mixed-media communications, events and programs. For example, HP provides employees with brown-bag informational seminars about installing solar roofs at their own homes and incentives for employees using solar energy. HP also supports grassroots employee sustainability networking.

#### Why the program was started: Operationalizing sustainability goals

HP's efforts to reduce our impact on the environment, to promote social and environmental improvements throughout our supply chain and to strengthen the communities in which we work and live would not be possible without the dedication and contributions of our employees. So we have a number of efforts underway that are focused on employee environmental education. Nearly half of my job at HP supports these efforts.

We began educating employees about the environment after learning about Wal-Mart's Personal Sustainability Program (PSP) through our relationship with them. Through a grass-roots effort by several employees in our Sustainability Network, it took off. Our environmental education efforts are an ongoing extension of our general awareness program that will incorporate more participatory capability on our intranet site in the future.

#### How the program works: Multimedia communications, events and programs

We use an approach that includes mixed-media communications, events and programs. Employees are busy, so we try to provide lots of resources and opportunities for them to get involved.

#### Live Green

One of our biggest programs is "Live Green." This began as a year-long program that includes articles on HP's Internet portal, six guest speakers whose presentations are recorded and webcast on the Internet portal and a kick-off event at which employees received ceramic coffee mugs and signed up for biweekly sustainability tips useful at home and at work. As part of "Live Green," employees can also make pledges to reduce their environmental impact. Pledges include organizing a beach cleanup, eating local/organic, planting trees, participating in Fresh Water Turtle Conservation with WWF and installing solar electricity.



#### Key Lessons:

- Support grassroots efforts with a variety of resources
- Use a combination of media for communications, events and programs
- Incentivize employees' actions at home
- Measure results
- Reach out to the less motivated



## Worldwide Participation

We also host Earth Day and World Environment Day events in every region of the world. These include community volunteering and bringing local companies and nonprofits to HP to raise awareness about the availability of green products, services and events.

## Sustainability Network Group

To support grassroots employee sustainability education, we have a Sustainability Network Group. Employees volunteer for Network Groups at different HP sites. The Network Groups, which are funded by a central HP budget, organize themselves as a chapter and develop a charter. Network Group projects have included educational discussion groups on topics such as technology and new business models for developing countries, innovation for the next industrial revolution and scientific challenges in sustainable energy technology. Other Network Groups develop onsite projects such as styrofoam cup reduction/elimination, providing recycling containers in every room and onsite gardens.

In Costa Rica, employees created a show on climate change called *Odyssey 2047*. All labor and facilities were donated for the event and the proceeds of ticket sales were dedicated to covering the cost of transporting students from the countryside to see a future presentation of the show. In England, employees started a project to generate hydro-electricity from the river Thames at the village of Goring in Oxfordshire. The dam is fish-friendly and highly efficient. All income will go back into the community and other sustainable activities. In Aguadilla, Puerto Rico, HP employee volunteers went door-to-door to give recycling totes and educate residents on the local recycling program, resulting in an increase in residential recycling from 15 percent to more than 50 percent. In 2008, five new chapters were started.

## Global Citizenship Report to Intranet

Communications through multiple media are important to support these different programs and to serve as a resource for employees. We produce a Global Citizenship report annually and a monthly newsletter that covers major environmental accomplishments and new initiatives. "My Voice" on HP's intranet portal is another element of our mixed-media communications approach. Employees can post stories about their sustainability initiatives at work and home, provide feedback and make pledges to reduce their impact. Through mid-2008, there was a tenfold increase in environmental messages on the portal.

**We use an approach that includes mixed-media communications, events and programs. Employees are busy, so we try to provide lots of resources and opportunities for them to get involved.**

### **Tangible Results: Solar power shaves 92 percent from the Bunka family's electric bill**

When temperatures in the San Francisco Bay Area soared over 100 degrees in May of 2008, HP employee Larry Bunka didn't sweat over turning on his central air conditioning. He had just seen the impact of his new SunPower residential solar system on his electric bill: In their first month of generating clean solar electricity, the Bunka family had reduced their bill down to \$12, the price the electric company charges for a meter. Sun Power was able to completely offset the family's electricity demands. Bunka says his meter now runs backwards during daylight hours, sending surplus electricity back to the grid.

## Solar Program

We also have a very popular employee solar program. HP provides employees with brown-bag informational seminars about installing solar roofs at their own homes and incentives for employees who use solar energy. More than 200 employees attended the first brown-bag seminar and 50 have installed solar roofs. The program was started after HP's installation of a 1.1-megawatt system of 6,256 SunPower solar panels at our San Diego facility. The system is projected to save us \$750,000 during the next 15 years, while providing more than 10 percent of the facility's power. As part of our agreement with SunPower, we started an employee program offering joint rebates to install solar electricity at their residences. The only problem is that the solar program is limited by a lack of incentives for solar in some states.





## Measuring results: It's hard to gauge the true impact

We do track results, but it's hard to gauge the true impact of these educational efforts on employee engagement. We measure webcast attendees and recorded viewings, the number of employees attending events, the number of subscriptions to environmental tips via email, the number of pledges received and the estimated carbon reductions resulting from the pledges. So far, we estimate CO<sub>2</sub> emission avoidance of over six million pounds, and over 500 cars taken off the road. Of course we also look for qualitative comments and feedback from employees. We've received a lot of positive feedback and appreciation for energy and water conservation tips, alternative transportation ideas and products that conserve energy. We've also received employee recommendations on what HP can do for product Design for Environment, energy and water conservation, and carbon footprint reduction.

## Challenges: Broadening the reach

Our main challenge is broadening the reach of the education efforts to employees who do not already have an interest in environmental or sustainability issues. We're always looking for new best practices and ideas to increase our reach.

## Next steps: Web 2.0 technology

We plan to use web 2.0 technology to further engage our employees and expand the interactive nature of our education efforts.

## Links to More Information:

HP Eco-Solutions:  
[www.hp.com/ecosolutions](http://www.hp.com/ecosolutions)

Global Citizenship Report 2007:  
[www.hp.com/hpinfo/globalcitizenship/gcreport/](http://www.hp.com/hpinfo/globalcitizenship/gcreport/)

HP Global Citizenship:  
[www.hp.com/hpinfo/globalcitizenship/index.html](http://www.hp.com/hpinfo/globalcitizenship/index.html)

"Burning Down the Office" on Youtube:  
[www.hp.com/hpinfo/globalcitizenship/environment/energy-tips.html](http://www.hp.com/hpinfo/globalcitizenship/environment/energy-tips.html)

Contact Christian Florensa:  
[christian.florensa@hp.com](mailto:christian.florensa@hp.com)

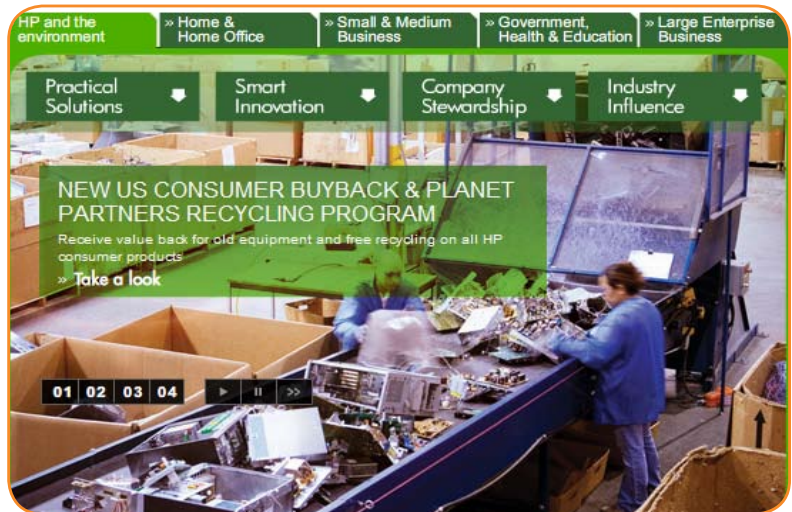

Our main challenge is broadening the reach of the education efforts to employees who do not already have an interest in environmental or sustainability issues. We're always looking for new best practices and ideas to increase our reach.



## “Ray”sing the Bar for Sustainability

### Case Study: Interface, Inc.

#### Company profile:

**Company:** Interface, Inc.

**Industry:** Commercial and residential floor coverings

**Headquarters:** LaGrange, Ga.

**Number of Employees:** 3,701

**Total Revenue:** \$1.1 billion

#### Interface’s Story

*Joyce LaValle, senior vice-president of Associate and Customer Engagement*

**Synopsis:** Interface, Inc. (Interface) is on a mission to have zero environmental footprint by 2020. To realize the mission, it has made sustainability part of every employee’s job. Interface uses several educational practices including job-appropriate training, storytelling and learning modules to support employee learning and development.

#### Why the program was started: An epiphany at the top of the company

Sustainability learning began at Interface in 1994 when our Chairman and founder, Ray Anderson, had an epiphany — an awakening to the importance of environmental issues and their relevance to Interface. This epiphany at the top of the company required extensive learning throughout the company to transform the organization according to Ray Anderson’s vision.

#### How the program works: It’s part of every employee’s job

There is nobody at Interface with a sustainability title; it’s part of every employee’s job. To operationalize the new direction, we developed a global advisory group to study sustainability and create a holistic plan for the company. Ray wrote a book about the plan, *Mid-Course Correction*, which was given to every employee. In the book, Ray lays out the underlying “why” as well as the entire plan. It is a great tool to help people to think about re-engineering a company to be more responsible. Since then, every year, there have been thousands of people at Interface working towards the plan through thousands of projects.

To support this mission, we use several educational practices, including job-appropriate training and storytelling, and we’re just beginning to create learning modules.

We began early on with empowerment training that included outdoor experiences. The goal was to open people up to expressing ideas and thoughts, to provide room for anybody to question anything. We also have provided employees “Natural Step” training.

Beginning in January 2008, InterfaceFLOR, the modular carpet division of Interface, Inc., introduced a new program designed to better introduce new associates to the company’s culture. Entitled “The InterfaceFLOR Associate Experience,” the site contains learning video modules or segments including: Welcome to Interface, Our Story (history), Our Customers, Our Mission, Our Process and Product, Our Community and Our Culture: Your Role at Interface.

#### Key Lessons:

- Make E&S part of a shared vision and the company culture, not a “flavor of the month”
- Measures are critical, and the best teacher
- Storytelling is a powerful tool
- Include all employees
- Consider E&S motivation and knowledge in the hiring process





## **Tangible Results: Interface employees neutralize personal travel emissions**

One of our most successful sustainability programs for our associates in Troup County (the county of Interface's headquarters) — Cool CO<sub>2</sub>mmute™ — was developed from an idea by one of our manufacturing associates — Lina Marshall. During a company meeting, Lina asked if there was a way non-sales associates could offset their travel emissions and Cool CO<sub>2</sub>mmute was born. Through this program, Interface associates make a voluntary personal commitment to reduce environmental impacts associated with their commute. By making a one-time yearly donation that the company matches, Interface and its associates neutralize personal travel emissions through the purchase and planting of trees through American Forests. For all Interface business units in the Americas more than \$10,000 was donated to American Forests in 2008 to sponsor the planting of trees that will result in more than seven million pounds of CO<sub>2</sub> being absorbed over their lifetime.

## **There is nobody at Interface with a sustainability title; it's part of every employee's job.**

In the modules, associates can see and hear directly from InterfaceFLOR's senior management about our processes and culture, as well as from some of our associates about what it's like to work at InterfaceFLOR. Associates also can hear from local community leaders about Interface's support in the local community, and they can hear from several of our clients about our customer service approach. The pages are designed to be interactive and informative and are being used as part of a larger revamped orientation process for new associates, as well as a great learning tool for all associates.

We also do a lot of face-to-face meetings with employees: monthly meetings with all manufacturing team members and quarterly team meetings with others. The meetings are intended to communicate progress, share technologies and breakthroughs and talk about future plans. Embedded in all of the conversations is discussion of progress related to sustainability and innovation.

All manufacturing team members are on a bonus program related to sustainability. Once a year we hold a ceremony recognizing several business units for progress along several fronts, including sustainability. The site that makes the most progress encounters a tougher year of improvement ahead because we expect continual improvement!

We have also started to use a StrengthsFinder survey administered by The Gallup Organization (the survey allows associates to identify their top natural talents that can be developed into strength) for our hiring process; we screen prospective employees to see if there is a good fit. We have more people, young people, applying to the jobs at Interface than imaginable — and they care about the mission! Sustainability is often the first conversation we have during the hiring process. People want to come to a job with a purpose.

We had developed and worked on our plan for 12 or 13 years before we realized that we had never really talked deeply to the outside world about our sustainability vision. So, as part of a global exercise, we branded all the pieces of our sustainability vision "Mission Zero®." It's not really a brand — it's a promise that by 2020 we will have no adverse environmental impact on the world. Stated another way, we aim to have zero footprint: every creative, manufacturing and building decision we make will move us closer to our goal of eliminating any negative impact our companies may have on the environment by the year 2020.

This was our first time to step out and be really bold about the sustainability vision publicly. At this point, we know we are so invested that we will continue this until 2020. We wanted the world to know about our vision so that we are held accountable by the outside world as well as by ourselves. The [Missionzero.org](http://Missionzero.org) website is being developed to help others join our mission — everyone is part of this. [Missionzero.org](http://Missionzero.org) is also an educational tool for our employees, a way to have a conversation about the promise and the clarity of the vision. In this and other ways, we are trying to keep the sustainability vision front and center everywhere at Interface.



## Measuring results: Material usage and employee engagement

We have developed goals and measurements associated with our overall plan. We measure all materials coming in and going out, energy usage, yarn usage, etc. Every measure has some relationship to creating a sustainable company and is communicated for use in departmental impact plans. We find that measures are, in themselves, critical and the best teacher.

In addition, starting about five years ago, we began measuring employee engagement throughout the organization, using a survey based on the Gallup book “First, Break All the Rules.” It includes 12 questions based on positive psychology that Gallup has developed for companies that want to be exemplary. If a company receives a high rating on these questions, it reflects deep engagement with employees. It is not a satisfaction survey nor is it specific to sustainability or Mission Zero. Sometimes we have areas that we need to work on, but in general, the scores show that Interface associates are deeply engaged with our sustainability mission and vision.

## Challenges: Addressing the “big” questions

Of course, we also encounter challenges: how do we keep making progress on our vision given the economy? How do we get off the grid affordably? How do we find the money to put reclamation technology throughout the world to get us off virgin materials? These are just some of the big questions. Our observation is that on the journey there are periods of struggle where it appears you can't make progress and then the breakthroughs come rapidly! We can't achieve our goal of zero impact without employee engagement. All of the innovation comes from employees.

**We have more people, young people, applying to the jobs at Interface than imaginable — and they care about the mission! Sustainability is often the first conversation we have during the hiring process. People want to come to a job with a purpose.**

**Educating employees about sustainability is important. But education alone can't make a company sustainable. What is really needed is a cultural shift and enormous commitment throughout the company. Sustainability can't be a “flavor of the month.”**

## Advice for others: Culture change is key

Educating employees about sustainability is important. But education alone can't make a company sustainable. What is really needed is a cultural shift and enormous commitment throughout the company. Sustainability can't be a “flavor of the month.” If employees learn about sustainability but the company doesn't have a plan and vision, they are likely to become cynical and then the education will be a waste of money for the company. If you turn people on to sustainability there needs to be a plan because they will take it up!

## Links to More Information:

Interface website on Mission Zero:  
[www.interfaceflor.eu/internet/web.nsf/webpages/528\\_EU.html](http://www.interfaceflor.eu/internet/web.nsf/webpages/528_EU.html)

Mission Zero Network:  
[www.missionzero.org](http://www.missionzero.org)

Ray Anderson on sustainability on You Tube:  
[www.youtube.com/watch?v=RcRDUIbT4gw](http://www.youtube.com/watch?v=RcRDUIbT4gw)

Gallup's “First, Break All the Rules”:  
[gmj.gallup.com/content/1144/First-Break-All-Rules-Book-Center.aspx](http://gmj.gallup.com/content/1144/First-Break-All-Rules-Book-Center.aspx)





# Environmental Literacy for a Healthy Planet

Case Study: Johnson & Johnson, Inc.

## Company profile:

**Company:** Johnson & Johnson, Inc.  
**Industry:** Pharmaceutical, Health Care  
**Headquarters:** New Brunswick, N.J.  
**Number of Employees:** 118,700  
**Total Revenue:** \$63.7 billion

## Johnson & Johnson's Story

*Tish Lascelle, senior director Strategy and Assurance, Worldwide Environment, Health and Safety*

**Synopsis:** Johnson & Johnson, Inc. (Johnson & Johnson) set a goal to improve environmental literacy among its employees by 2010. Within the first year, 92 percent of Johnson & Johnson's facilities had an environmental literacy plan and 79 percent of facilities had deployed an annual environmental literacy module.

## Why the program was started: Setting goals to improve environmental literacy

Johnson & Johnson's culture is built on its credo, written 65 years ago. One of the Company's values is that being good to the environment is good for business. We've had environmental

## Key Lessons:

- Build on existing company culture
- Tailor the messages for the audiences
- Provide resources, not a prescriptive approach
- Use repeated, frequent messaging and multiple media
- Appeal to employees' hearts, and involve kids
- Work with partners outside the company



goals for over 15 years, and because of this, we've always had at least informal awareness of environmental issues among our employees.

In 2005, we developed our newest set of sustainability goals after extensive stakeholder engagement. As part of our "Healthy Planet 2010" goals (covering 2006 to 2010), we set a goal to improve environmental literacy. More specifically, we want to increase employee awareness and understanding of global environmental issues and how individual behavior and actions may impact the environment on a global scale. Each of our facilities will implement one environmental education campaign each year from 2006 through 2010.



Our motivation was that if employees “get it” on environmental improvement, they make more effort at home and in their personal life, but they also bring this awareness to work. Since we’ve had environmental goals for 15 years, the low-hanging fruit for reducing our impact is gone and we need to engage employees to identify the next level of environmentally friendly products and processes.

### **How the program works: Locally tailored thematic campaigns**

Each year, the campaign theme focuses on a key pressing environmental issue. Each campaign addresses what employees are doing both at work and at home. The first year, we created awareness around all of our “Healthy Planet 2010” goals. In 2007, the topic was climate change. In 2008, we discussed sustainable forestry using a campaign themed “Seek the Source.”

We produce a resource packet that includes a variety of communication devices to choose from, such as on-line environmental information, e-Learning, designs for collateral materials, web meetings and conferences and brochures. The environmental campaign themes originate from our headquarters, along with the content, messaging and materials for the campaign. The resources are then distributed to the environmental health and safety managers at operating facilities, who decide how to adapt and run the campaign in the way that best fits that facility. For example, an operating company in Asia may need to tweak the message for their culture and they would also do any desired translations.

**We actually set a goal to improve environmental literacy. More specifically, we want to increase employee awareness and understanding of global environmental issues and how individual behavior and actions may impact the environment on a global scale.**

**Since we’ve had environmental goals for 15 years, the low-hanging fruit for reducing our impact is gone and we need to engage employees to identify the next level of environmentally friendly products and processes.**

We develop the materials for each campaign ourselves with the help of external partners — often seeking out subject matter experts and partners from NGOs (non-governmental organizations) and the government. For example, when we wanted to educate employees about sustainable forestry, we partnered with the World Wildlife Fund to be sure we depicted the issues accurately. We don’t want to reinvent the wheel, so we do a lot of web research to see what’s available in the public domain first. In some cases we find good, relevant information but in other cases, information is not readily geared to employees.

Johnson & Johnson is the parent company for about 250 operating companies. We are decentralized in the way we operate and view accountability. We create programs and materials to promote environmental literacy but we do not dictate or mandate implementation terms. We are best positioned at headquarters to create the materials and to put the information in context for Johnson & Johnson employees. Deployment depends on the operations staff — the EHS professionals.

This has actually worked to our advantage. Years ago, we did safety campaigns at Johnson & Johnson with campaign material boxes filled with printed supplies and videos. These campaigns were prescriptive and expensive to produce. We found that operating facilities like to have the freedom to tweak messages and materials. So with the environmental literacy campaigns we provide raw file logos, PowerPoint documents and other materials in English and allow the facilities to tailor the materials. We don’t try to control the campaigns, and this has actually been one of the stronger aspects of what we have done. Although there is a flip side: there is some extra time and cost involved on the part of facility staff if they adapt the materials.



## Measuring results: Developing and deploying environmental literacy plans

By 2006, 92 percent of facilities had an environmental literacy plan and 79 percent of facilities had deployed an annual environmental literacy module. We don't formally track employee awareness and literacy or the effectiveness of the campaigns other than through anecdotal feedback. We decided from the beginning that we were just going to do this well, and promote general awareness. Overall, we've had great success creating awareness among employees.

We have gotten feedback that people like having a menu of options that is not prescriptive. And, we get positive feedback on providing things that are geared to children. For example, we have children's energy-week coloring contests and we provided employees with a children's book related to climate change, by A.L. Russo, "Brother Bear and the Thin Ice." When you get an employee to take something home to their family, we consider the campaign a success. We try to include something for kids in each campaign.

## Challenges: Competing for mind share

In general, we find that with over 120,000 employees, different things motivate different people. The biggest challenge is getting our share of the attention given other, competing business demands. There is no magic bullet. The information needs to be relevant, and it needs to be tailored locally. People are proud to work for Johnson & Johnson and its operating companies, and they want to feel that the company cares. So, we discuss successes and progress and go after their hearts a bit. If employees can share what Johnson & Johnson is doing to reduce its environmental impact with friends and neighbors that goes a long way.

**We're decentralized, so it's about influencing and promoting general awareness that builds off of the company's culture and goals. Frequent messages, in a variety of media, work well; it's not about having a once a year Earth Day fair.**



Most importantly, you have to know the corporate culture that you're trying to promote environmental literacy in. We're decentralized, so it's about influencing and promoting general awareness that builds off of the company's culture and goals. Frequent messages, in a variety of media, work well; it's not about having a once-a-year Earth Day fair. The messages need to be repeated and connected to the day-to-day operations of the company. For example, you can do something at an Earth Day related to forests, but then connect it to napkins in your cafeteria later.

## Next steps: Campaign focus on general sustainability topics

In 2009, we plan to focus our environmental campaign theme more on general sustainability topics.

## Links to More Information:

"Seek the Source" on You Tube:  
<http://www.youtube.com/seekthesource>

Johnson & Johnson 2007 Sustainability Report:  
<http://www.jnj.com/wps/wcm/connect/b92d59804ae70ee5bc98fc0f0a50cff8/2007-sustainability-report.pdf?MOD=AJPERES>

Johnson & Johnson website:  
<http://www.jnj.com/connect/caring/environment-protection/>

Contact Tish Lascelle:  
[elascell@its.jnj.com](mailto:elascell@its.jnj.com)





# Making Sustainability Personal

## Case Study: Wal-Mart Stores, Inc.

### Company profile:

**Company:** Wal-Mart Stores, Inc.

**Industry:** Retail

**Headquarters:** Bentonville, Ark.

**Number of Employees:** more than 2 million

**Net Sales:** \$401 billion

### Wal-Mart's Story

*Janelle Kearsley, director, Private Label Sourcing; Miranda Anderson, director of Corporate Affairs, Sustainability; Candace Taylor, director, Strategy & Sustainability*

**Synopsis:** Wal-Mart, the world's largest retailer, has the size and scope to influence change throughout the industry. Wal-Mart believes that its associates are critical in the company's efforts to become a more sustainable business. Its Personal Sustainability Project has engaged more than 500,000 associates voluntarily in its sustainability efforts, demonstrating measurable results in associates' lives and in the workplace. Additionally, Wal-Mart's Sustainable Value Networks engage salaried associates, and all salaried associates' performance evaluations include a question on the associates' contribution to sustainability.



### Why the program was started: By Wal-Mart Associates, for Wal-Mart Associates

As a global retailer, we recognize that we have a unique opportunity to participate in positive and sustainable change throughout the supply chain and into the homes of millions of people. This gives us the ability to fundamentally shift the way products are sourced, manufactured, delivered and sold. We believe that we can be a good steward of the environment and a good neighbor to communities around the world while growing a profitable business. We also believe that we can do this while saving our customers money so they can live better.

### Key Lessons:

- **Make E&S outreach personal and voluntary**
- **Grassroots and personal involvement is essential**
- **Engage employees in setting goals**

As a company, we are working to be supplied 100 percent by renewable energy, produce zero waste to landfill from our stores, and sell products that sustain our resources and the environment. Using an approach we call Sustainability 360, we are working to achieve these goals and bring sustainable solutions to our roughly 61,000 suppliers, 176 million weekly customers around the world and more than two million associates. Sustainability 360 lives within every aspect of our business, in every country where we operate, within every salaried associate's job description and extends beyond our walls to our suppliers, products and customers. Overall, Sustainability 360 is about doing better for our customers, our associates, our suppliers and our environment—and doing it together.

Within Sustainability 360, we are engaging our more than two million associates in our sustainability efforts through two parallel avenues that involve listening to and working closely with our associates. Our associates around the world have the ability to educate their friends, family and communities on sustainable practices. We are educating them on the environmentally friendly and ethical products that are on our shelves so they can, in turn, teach our customers about those products. In 2007, we introduced a voluntary, grassroots



program called the Personal Sustainability Project (PSP) to all of our U.S. associates. PSP guides associates as they integrate environmentally friendly and healthy practices into their lives and make choices that benefit their communities. The program was started by Wal-Mart associates for Wal-Mart associates. It enables our 1.4 million U.S. associates to live healthier, more sustainable lives at work, at home and in their communities. The program has grown to include associates around the world and has been successfully implemented in Brazil, Canada, China and Mexico. Additionally, for our salaried associates, we have engaged them in our Sustainable Value Networks and added an additional sustainability component to their annual reviews.

### PSP: Program Design

**(Sustainability) relates to every single associate at Wal-Mart...If we have 2.2 million associates worldwide, I'd love for every associate in every country to really recognize their personal, individual responsibility in the area of sustainability.**

**– Mike Duke, CEO of Wal-Mart Stores, Inc.**

When we began developing the PSP program, we wanted to make sure that we were building a program that would be meaningful to our associates. We started by asking associates, “What does sustainability mean to you?” Their response was clear; sustainability had to be personal and relevant in their everyday life. From this insight, we developed the three main principles behind the PSP program:

1. It has to be personal and relevant.
2. It has to be voluntary.
3. It has to be bottom-up.

There are five general focus areas for PSPs:

1. Sustainable Purchasing
2. Waste Reduction
3. Health and wellness
4. Energy
5. Clean air and water



**The goal for our PSP program design is to bring small change into the lives of our associates that can improve their own well-being, as well as the health of the environment and communities.**



PSP goals are chosen using the “SMART” goal framework:

- “S” – Sustains the planet
- “M” – Makes them happy
- “A” – Affects the community
- “R” – Regular and continuous in daily life
- “T” – Takes visible actions that can be shared with others

The goal for our PSP program design is to bring small changes into the lives of our associates that can improve their own well-being, as well as the health of the environment and communities.

## PSP Implementation

Working with a consulting firm, we were able to develop associate education and training materials, determine a roll-out strategy and begin implementing the program into stores across the U.S.

Our first step in the implementation process was to have each store select two volunteers to attend a day-long, paid training session. Initially, our human resources department paid for headquarters training and the pilot training and the operations team paid for operations staff training. These retreats were held in natural settings, such as a state park. In the morning, we would lead participating associates through a discussion that focused on sustainability and Wal-Mart’s environmental goals. In the afternoon, the discussion turned to educating associates on the Personal Sustainability Project, how to develop a PSP and how to encourage others to join the program. The first training session reinforced the importance of all PSPs being voluntary, personal in nature and focused on the local community. At the end of the session, each participant developed their own PSP — a small change that will help benefit their own life, and the health of the environment and local community — such as biking to work, quitting smoking or losing weight.

After completing the training, each volunteer became a PSP captain and was given the challenge to recruit 10 co-workers and train them to introduce PSPs to other employees. Through this design, captains are able share stories and the definition of a PSP and then let associates decide for themselves whether to adopt a PSP. Currently, we have approximately 46,000 PSP captains (about 10 per store and club), and host 120 retreats throughout the year. Captains serve as the sustainability advocates for our company in each store or club. In addition, in-store TV clips profiling employees and their PSP stories and a PSP-focused magazine complement PSP captains’ efforts.

## PSP Results: A truly grassroots sustainability movement

The project was piloted in Denver, Indianapolis and Tampa in 2006, and rolled-out to our Bentonville headquarters and Sam’s Club stores in 2007. It is now deployed to 4,000 stores, and more than 500,000 associates have developed PSPs. The program has about a 50 percent rate of acceptance. Currently, we track the number of associates who adopt a PSP, the type of PSP and associates’ success in aggregate.

As of September 2007, associates reported that they voluntarily recycled:

- 675,538 pounds of aluminum,
- 282,476 pounds of glass,
- 5,953,357 pounds of paper and cardboard and
- 3,177,851 pounds of plastic.

**Walking the Walk**

Home Office Associates Taking Personal Sustainability Steps, Report Results, and Learn More About the Personal Sustainability Project

**PSP**

Personal Sustainability Project

Join the thousands of Home Office Associates taking part in the Personal Sustainability Project. PSP is a voluntary, grassroots effort that brings sustainability into our personal lives. It starts by choosing your personal sustainability practice — one simple change in your life you can get passionate about.

What's your PSP?

**WAL-MART**





They have also:

- Walked, biked and swam more than 1,109,421 total miles,
- Cooked 368,779 healthy meals,
- Quit smoking (nearly 20,000),
- Lost a total combined weight of 184,315 pounds through PSPs and
- Shared the PSP program with 375,824 of their friends, family and community members outside of Wal-Mart.

Due to the differences in each Wal-Mart community and the associates who call that region home, PSPs can be very different across the country. Stores might focus on wetlands conservation, recycling in the community or education about climate change. And some stores are more engaged than others. Ultimately, our results have shown that our associates are motivated by PSPs when they save money, build friendships and support networks at work, and see the results of other associates' successful PSPs.

### **Tangible Results of PSP Program: Employees Making a Difference**

Darryl Meyers, from the Burlington, N.C., store noticed that the vending machines in the break rooms glowed with lights around the clock. He suggested to Wal-Mart's energy division that they remove those lights to reduce energy consumption. Darryl not only made a suggestion that was good for the environment, but his idea also helped the company save nearly \$1 million in electricity bills every year.

Another employee, Shonda Godley, who works in Wal-Mart's People Division at the Home Office in Bentonville, Ark., is working to turn her family's farm into an educational, organic farm. Shonda's family farm traditionally produced wheat and maize, but now she would like to put the farm in a trust to a local college to be used as a training and learning facility for organic farming methods.

### **Challenges: Keeping it fresh**

As new associates join our company, and as others stay on, we have encountered a challenge of keeping the program informative and educational, while continuing to motivate and inspire long-time participants in the program. In 2008, we designed our PSP curriculum around feedback we received from our associates. By dividing the year-long curriculum into four topic-focused quarters, we were able to address some of the high-priority areas identified by associates. Our 2008 program educated associates on environmentally sustainable products carried in our stores, health and wellness, community engagement and financial information and money-saving tips.

### **Next steps: International expansion**

While PSP has never been officially introduced to our international markets, through word of mouth, many of our international associates are developing PSPs. We are hearing great stories from our associates in Canada, Japan and China.

### **Sustainable Value Networks (SVNs): Aligning business and sustainability goals**

**My challenge to you is to move sustainability to the front burner, if you don't already have it there, because it will be about your leadership and your future. We need to have 100 percent participation and we need to have full effectiveness in all of our efforts.**

**—Mike Duke, CEO of Wal-Mart Stores, Inc.**

Our associates are critical to our effort to become a more sustainable company. Since our sustainability initiatives affect so many business divisions, we established Sustainable Value Networks (SVNs) led by management associates within those divisions instead of simply creating a "Corporate Social Responsibility" division. When we launched our Sustainability 360 program, we wanted our associates to realize that this was a long-term program and part of our company-wide commitment to communities around the world. Though not designed as an educational program, the SVNs have been important in raising



awareness of environmental issues and identifying opportunities to improve our business and the environment simultaneously.

Each SVN is responsible for developing initiatives that drive sustainability into specific business divisions and align with one of the overarching company sustainability goals.

### Sustainable Value Networks

- Energy Goal: Greenhouse Gas Network, Alternative Fuels Network, Sustainable Buildings Network, Logistics and Fleet Network
- Waste Goal: Operations and Procurement Network (Waste), Packaging Network
- Products Goal: Food and Agriculture Network, Wood and Paper Network, Jewelry Network, Textiles Network, Chemicals Network and Electronics Network

Our SVNs not only include Wal-Mart associates, but also representatives from non-government organizations (NGOs), supplier companies, academic institutions, government agencies and other thought leaders who help us identify and execute meaningful changes in our business. Armed with the collective knowledge of each SVN, we can identify greater opportunities for improvement and develop innovative solutions in each business division. This collaborative approach has helped us in many instances, including our efforts to remove harmful chemicals from electronics and to bring sustainable fishing practices to our seafood suppliers around the world.

We involve salaried associates at all levels in the SVNs. In fact, the governance structure of the SVNs includes our executive leadership, top management, division leaders and other associates at various levels throughout our company. Network activities are monitored and managed at a number of levels and are reported directly to our CEO.

Many of our managers were immediately engaged with the efforts through the SVNs, but to truly make sustainability live within our business we decided to make it every salaried associate's responsibility. Starting in 2008, we added a component to all of our salaried associates' annual reviews that evaluates their contribution to moving our company's sustainability goals forward. We have found that our associates are bringing some of the best ideas to the table to make our company more sustainable.

### Links to More Information:

Wal-Mart sustainability:  
[walmartstores.com/Sustainability/](http://walmartstores.com/Sustainability/)

Wal-Mart fact sheets on PSPs and sustainability:  
[walmartstores.com/FactsNews/FactSheets/#Sustainability](http://walmartstores.com/FactsNews/FactSheets/#Sustainability)

Wal-Mart's Sustainability 2.0 video:  
[www.walmart.com/catalog/product.do?product\\_id=10237022](http://www.walmart.com/catalog/product.do?product_id=10237022)

Contact Candace Taylor:  
[candace.taylor@wal-mart.com](mailto:candace.taylor@wal-mart.com)

### SVN Governance Structure (As of February 2009)

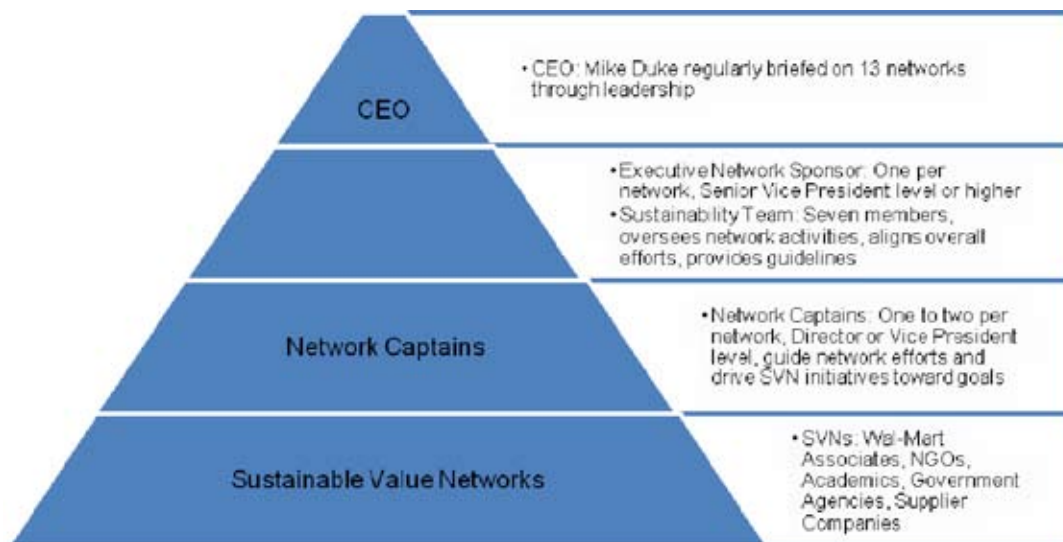



# MAPing a Route Toward Sustainability

## Case Study: Stonyfield

### Company profile:

**Company:** Stonyfield

**Industry:** Food

**Headquarters:** Londonderry, N.H.

**Number of Employees:** 500

**Total Revenue:** \$340 million

### Stonyfield's Story

*Nancy Hirshberg, vice-president of Natural Resources*

**Synopsis:** At Stonyfield, Inc. (Stonyfield) employee engagement and education on E&S issues begins with the hiring process. Then Stonyfield's Mission Action Plan (MAP) engages all employees in its sustainability mission through on-going education and training and by linking long-term environmental impact goals to job performance measures of key personnel.

### Why the program was started: Engaging employees in the sustainability mission

One of the things I'm most proud of at Stonyfield is our Mission Action Program (MAP) for engaging employees in our sustainability mission.

Historically, Stonyfield has never screened potential employees for environmental literacy, so our employees are no more interested or knowledgeable about environmental issues than the general population. Through an assessment, we found that approximately 10 percent of our employees were managing 95 percent of the company's environmental impact. We began MAP in 2006 to engage more fully this key employee group in our sustainability mission. To our surprise, MAP evolved to engage all of our employees more fully in sustainability.

### How the program works: Long-term goals linked to job performance measures

MAP has truly transformed the company. MAP is built around Stonyfield's 11 primary areas of environmental impact, with cross-functional teams assigned to each impact area. The teams include: transportation, facility, greenhouse-gas emissions, milk

production, sales, zero waste, green chemistry, water, sustainable packaging, ingredients and SWOT (Stonyfielders Walking Our Talk). Unlike the other teams that focus on the company's areas of greatest environmental impact, SWOT focuses on high visibility but lower-impact issues like events and office supplies.

The MAP teams set long-term goals — such as zero waste — and complete yearly action plans for each goal. Our CEO, COO and I must approve the plans. The team members also have a portion of their compensation linked to achieving an annual MAP objective.

As a result of the MAP action plans, we now have company goals in place for our major areas of environmental burden, including facility energy, facility greenhouse gas emissions, percent renewable energy for our manufacturing facility, packaging and transportation. MAP team employees receive bonuses based on achievement linked to these action plans. In addition, all capital improvement plans are reviewed and must be demonstrated to support the MAP goals. The result has been huge environmental savings such as elimination of solid waste and reduction of transportation greenhouse gas emissions.

The core group of employees involved in MAP felt that they had benefited so greatly professionally and personally from the program that they urged us to find a way to engage all of our employees in the process. In 2007, we held MAP trainings for every department. From production line workers to executives, everyone had an opportunity to learn about global environmental issues, with a focus on climate change. They learned about our company's impact on the environment and

### Key Lessons:

- Tie E&S education to the company's mission and goals
- Focus on key impact areas and set improvement goals
- Make E&S relevant to job performance evaluation
- Assess E&S knowledge and motivation part of the hiring process



ways that they could help reduce environmental burdens at work and in their personal life. Also that year, we began a daylong orientation for all new employees on Stonyfield's mission, including MAP. We report monthly on MAP goals and progress in our in-house "moosletter." In 2008, one of the MAP goals — on facility energy use — became part of the bonus plan for all employees. We achieved the annual goal — reducing our energy use per ton of product by over 22 percent — and employees received a bonus. Currently, Human Resources is working to incorporate MAP goals into all employees' job descriptions.

### **Measuring results: Gains in key areas**

MAP has resulted in huge environmental savings. In 2007 we reduced transportation greenhouse gas emissions by 40 percent. We eliminated the equivalent of 18 tractor-trailer loads of plastic. We achieved a 28 percent reduction in facility energy use per ton product. And, 100 percent of Stonyfield products became organic.

In 2008 we achieved similar results by engaging employees in MAP. We reduced transportation greenhouse gas emissions by an additional 10 percent and energy use per ton of product by an additional 22 percent, compared to 2007! Our recycling rate is up by 13 percent, and our trash generated is down by 21 percent per ton of product. And, SWOT formed seven groups that are making improvements in a wide range of areas: office operations; clothing; premiums and gifts; travel and fuel; trash, compost, recycling; food and caterers; office equipment and energy use; paper, printing, copying and faxing.

### **Challenges: Staying focused**

Despite the success we've achieved, we still face challenges. One of our biggest challenges is turnover and the need to continually educate new employees. It's also difficult getting people think "outside of the box" — to move beyond eco-efficiency to truly sustainable thinking.

We also have to manage employee expectations. Many employees who have roles with very little impact want to be actively involved. We need to focus our efforts on the highest-yielding projects — those with the greatest environmental and financial benefit. That involves very few people. So the challenge is supporting everyone else without diverting limited resources (time being key) away from key initiatives. There is never enough time or money.

**Through an assessment, we found that approximately 10 percent of our employees were managing 95 percent of the company's environmental impact. We began MAP in 2006 to engage more fully this key employee group in our sustainability mission. To our surprise, MAP evolved to engage all of our employees more fully in sustainability.**

### **Next steps: Seeking step change**

We're moving to the next level through training in innovation — thinking beyond eco-efficiency and more about products, processes and practices that transform our company. We're looking now for the step changes that will move us to more sustainable business practices.

### **Links to More Information:**

Stonyfield Mission Action Plan:  
[www.stonyfield.com/EarthActions/Environmental%20Practices/ReduceEmissions.cfm](http://www.stonyfield.com/EarthActions/Environmental%20Practices/ReduceEmissions.cfm)

Stonyfield Earth Actions:  
[www.stonyfield.com/EarthActions/](http://www.stonyfield.com/EarthActions/)

Gary Hirshberg on You Tube:  
[www.youtube.com/watch?v=MstLwDog2Es](http://www.youtube.com/watch?v=MstLwDog2Es)





## Hanging in There

Case Study: The Accessory Corporation, Inc.

### Company profile:

**Company:** The Accessory Corporation, Inc.

**Industry:** Plastic garment hangers

**Headquarters:** New York, N.Y.

**Number of Employees:** 2,500

**Total Revenue:** \$1-\$100 million range

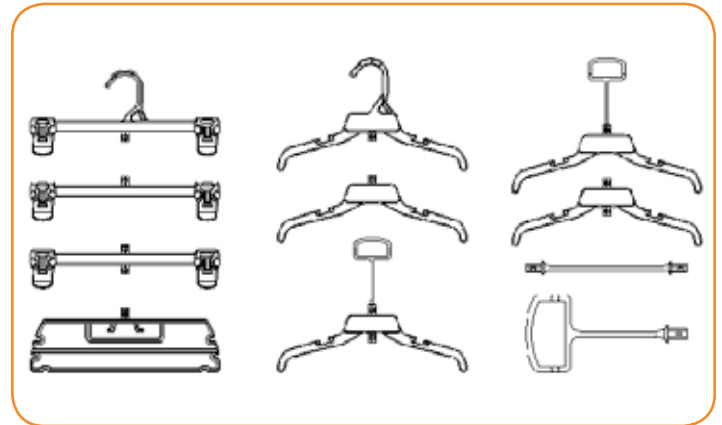

### The Accessory Corporation's Story

*Steven Sutton, President*

**Synopsis:** The Accessory Corporation, Inc.'s (TAC) environmental and sustainability education journey began with attendance of top management at an in-person training seminar supported by one of their major customers. The managers took the information back to TAC and shared it with other employees. As a result, TAC developed a new hanger design using renewable material and a re-use program.

### Why the program was started: A challenge from a major customer

Everyone is interested in using the “sustainability” buzzword, but it's not an easy feat to become a truly sustainable company or even to know how to take the first step when you manufacture plastic garment hangers! Environmentally, plastics are a difficult case to deal with.

In our industry, we are totally driven by our customers, the retailers. Without their support, it's hard to find an alternative to plastics. Our sustainability journey began with a challenge from one of our major retailers to become more sustainable. To

### Key Lessons:

- Customer support is key
- Include all functions in the search for solutions
- Persistence

help us begin the journey they provided us with an educational training program through a group called Blu Skye. The training program has made me really passionate about sustainability.

### How the program works: Educating change agents who educate fellow employees

I started taking classes from Blu Skye in January of 2008. To be honest, the first time, I just went to look good for the retailer. But I found I learned a lot and kept going back. Now, my employees and I have been through four different training programs, each of which is about five hours long.

The training was focused on reducing packaging. It really helped me to think outside the box — literally! It was very hands on. They would hand us an object — a child's toy, for example — along with it's packaging and ask: “From start to finish, how can you reduce the packaging for this object?” It really helped me to think more seriously about using environmentally friendly alternatives to plastics such as corn, and to think about what you do and don't need for packaging.

Since then, I have taken the information back to TAC and shared it with other employees. We formed a group to think about how we could improve our hangers to make them more sustainable. We included engineering, quality control and operations employees in the discussions. Sustainability is such an up-and-coming focus that it touches every aspect of the business; everyone needs to be involved. We have people on the assembly line packaging the hangers who might have insights that someone behind a desk wouldn't.

First, we looked at how we were making hangers and from what materials. So far, we have come up with new hanger designs that reduce packaging by 30 to 50 percent. At the same time, from



an efficiency point of view in production, we are able to increase our molding capacity by almost double by getting more cavities (impressions) per mold. (Hangers are made from injected mold impressions on a piece of steel.)

Then we focused on reuse. The reuse concept has been around since before 1996 for hangers, but in higher-end product retailers' stores. With the savings in energy and packaging from the new design, we were really inspired to reduce our environmental impact and started looking into reuse programs for our hangers. For one retailer alone, we may produce 2 billion hangers a year. So, we figured if you re-use, you really reduce your impact. We also learned that we would receive tax breaks for reusing our hangers. We are trying to get five or six lives out of the same product now.

### **Measuring results: Creative design reduces packaging by 30 percent**

Our new hanger design actually doubles the capacity of the mold, which lessens labor, energy, cooling, and heating costs. Then when we take the hangers off of the mold we are getting 30 to 50 percent more in a box.

**Sustainability is such an up-and-coming focus that it touches every aspect of the business; everyone needs to be involved.**

### **Challenges: Retailer support and need for government incentives**

One problem we encountered is that it takes a lot of logistics on the retailer's side to try a reuse program. In most cases the retailers already have people in place to help with a reuse program but it's hard to get them to think outside of the box because hangers are not a consumer-based product. A hanger is just a hanger. Typically, the consumer throws it away once they get home.

Retailers do support reuse programs, but we all need government support. We need a mandate or a tax credit for the retailers to encourage the reuse of hangers. Carbon credits might also help to incentivize reuse of hangers.

**We really need all of our employees to be engaged and our retailers supportive for our new hanger design and reuse programs to become actionable.**

We really need all of our employees to be engaged and our retailers supportive for our new hanger design and reuse programs to become actionable. I'm optimistic. At a time when no one is buying clothes and sales projections are down 20 percent from last year, a new hanger design partnered with a renewable material and re-use program is a home run for retailers' bottom-line and a grand slam for retailers' customers and the environment.

### **Next steps: Renewable materials and a reuse program**

It's hard in today's economy to take action. We have tested several products that are not oil-based but they are more expensive than traditional hangers. Renewable materials and incentivizing a reuse program are the next big steps. Even if we can just focus on one aspect at a time I think the company is doing well.

### **Links to More Information:**

Blu Skye:  
[www.bluskye.com/](http://www.bluskye.com/)

Sustainability at the University of Arkansas:  
[sustainability.uark.edu/](http://sustainability.uark.edu/)

Contact Steve Sutton:  
[info@theaccessorycorp.com](mailto:info@theaccessorycorp.com)





## They Aren't Monkeying Around

Case Study: Clean Clothes, Inc.

### Company profile:

**Company:** Clean Clothes, Inc.  
(brand name Maggie's Organics)  
**Industry:** Apparel  
**Headquarters:** Ypsilanti, Mich.  
**Number of Employees:** 13  
**Total Revenue:** Decline to state

### Maggie's Story

*Bena Burda, president and owner*

**Synopsis:** Clean Clothes, Inc., (Maggie's) does not have a formal environmental education or training program; at Maggie's, environmental education is integrally connected to the product. The company works with business partners to improve environmental practices. It also screens new employees for their knowledge about organics and organic cotton. As a result, the corporate culture attracts employees who are environmentally aware.

### Why the program was started: From organic tortilla chips to sock monkeys

The idea for Maggie's Organics began in 1992 with an organic tortilla chip. We were in the food business, busy selling both blue and yellow corn tortilla chips, when one of our farmers recommended adding cotton to the crop rotation to improve the quality of the corn. His experiment worked. However, his cotton yielded a crop and we were expected to sell it!

We knew about selling food, not cotton. But we did feel a sense of loyalty to all of our farmers, as we were all swimming upstream back then. Once we started learning about the intense chemicals used to grow cotton, my partner and I figured we had a marketing story.

We decided to make garments a different way — using our farmer's organic cotton to avoid the harsh facts of conventional cotton cultivation and garment manufacturing. We started with socks, and then added tee shirts: simple products that would encourage the use of organic fibers in order to convert as many acres of land as possible from conventional to organic farming methods.



© Clean Clothes, Inc.

All of our sewing contracts were in the United States and we had many problems with late orders and poor quality. Then we started losing sewing contractors to bankruptcy (the U.S. apparel industry was starting to move offshore) — a total of six in 18 months. We had to move all our own sewing offshore or we would be out of business. But how would we find an offshore contractor that wasn't a sweatshop? The solution: a worker-owned sewing facility in Nicaragua, The Fair Trade Zone, trying to help 30,000 refugees of Hurricane Mitch. Our partnership with The Fair Trade Zone has inspired us to pursue other projects. So now we're making monkeys from "less than perfect" crew socks filled with mill scraps, with a 100 percent worker-owned co-operative in North Carolina.

### Key Lessons:

- Embed sustainability in your culture and product
- Foster a culture of learning
- Involve all employees in problem-solving
- Use credible third-party information to make the case for environmental improvements
- Influence the supply chain through education and dialogue
- Make the business case internally and with business partners



The origins of our cotton production and our work with worker-owned co-operatives are examples of Maggie's strong environmental and social values. We've never had a formal environmental education or training program. At Maggie's, environmental education is part of everything we do, and is reflected in our products and how we run our business and work with employees. It's part of our mission, values and founding principles and therefore it's important for all employees to be involved in environmental decision-making.

### **How the program works: It's part of the product**

We start at the beginning by screening new employees for their knowledge about organics and organic cotton. As a result, we have a corporate culture that attracts employees who are environmentally aware. We started out using a lot of packaging because we wanted to tell people about organic cotton and spread the message. However, we've since moved away from that kind of packaging to a small brown band.

Our decision to reduce packaging was based on two things: a sense of guilt and the development of loyal customers. The guilt part was obvious — here we were basing our entire business on converting acres of land from conventional to organically grown production and yet we used so many resources to promote our product. Plus, we needed to present a lot of data to each consumer when we started, but after five years, we had succeeded with at least one thing: the customers who like our socks bought them repeatedly. So repeating all those messages on each package became redundant. We also decided to let the product speak for itself. Beginning in the late 1990s we tried to develop sales based solely upon the quality, feel and durability of our products, and let the fact that they were environmentally made be just one more value added. It has worked well for us.

Aside from reducing packaging, we also try to “walk the talk” around our office. We completed an extensive energy audit of our office building last year and now have a programmable thermostat. A few years ago we had a community garden down the road. And, we try to do little things around the office; we don't use sticky notes and we always print double sided.

We also use regular cross-company review sessions. Whether designed around a product or service, or an area of the business, we meet in an empty room and just throw the topic on the table and ask for random and off-the-wall comments. At times I find that people who have the least familiarity or expertise in a given

**Maggie's is small, so there is no single champion or department for environmental education — all employees are involved. And our impact has really spread beyond our 13 employees.**

area end up having brilliant insights. Again, our situation may be unique, as we tend to attract idealistic people, but I think everyone wants to believe in their work environment.

Maggie's is small, so there is no single champion or department for environmental education — all employees are involved. And our impact has really spread beyond our 13 employees.

### **Measuring results: Not yet**

We don't track environmental education or engagement at this point, but would like to.

### **Challenges: Making the business case**

In the apparel industry, you typically have a larger field of influence outside of your own doors than you do within them. We share our knowledge about environmental practices for apparel production with our partners in Nicaragua as well as U.S.-based manufacturers. The apparel industry is under duress, so making the business case is an important motivating factor. For example, we worked with one sock finisher to switch from chlorine to hydrogen peroxide. And it saved him money!

In my experience, the toughest thing is convincing the management of our business partners to listen and to think outside the box. When suppliers are under financial duress, it is sometimes tough to entertain new practices.

### **Advice for others: Credible third-party information helps make the business case**

We've found that credible third-party information really helps make the business case for environmental improvements. For



## Tangible Results: Taking action at home

"As one of the few individuals in the office that did not come from an environmentally friendly background, I have made a lot of changes in my personal life since starting at Maggie's.

"I have always recycled, but really ramped up the reduce/reuse/recycle mantra at my home, as well as the homes of my friends and families. We have started re-gifting items that are no longer useful / needed, as well as joining our local Freecycle organizations to pass on the items that may still be useful to someone outside of our immediate circle.

"My shopping habits have been altered to better support local and non-chain businesses. I've also increased the amount and variety of items that I buy in bulk quantities to reduce the amount of packaging that comes into my home. Several of my friends have also started a sort of "buying club" for bulk purchases so we eliminate the amount of waste that comes from overbuying perishables. This is especially important when paying a premium for organic produce.

"Not long after I started working here, Maggie's Organics was listed in 'The Better World Shopping Guide' — this book has helped guide me toward better choices for things I already purchase, such as laundry detergent, or towards gasoline companies that have better environmental records. I am slowly replacing all of my 'regular' cleaning products with green products, as they run out. I am doing the same with personal care products. All of the lawn care products I use are organic and environmentally friendly."

– Karrie Black, special projects manager, Maggie's Organics

## We've found that credible third-party information really helps make the business case for environmental improvements.

example, the Ecology Center created a Healthy Toy Rating that includes our new sock monkey. Our favorable inclusion in this rating was of interest to one of our larger customers, Whole Foods. A credible third party helps to make the case because we are already seen as the "green geeks."

In our case, reading our customers' comments always helps too. In today's world of informed consumers, we often receive comments and questions that may at first seem off-the-wall, but can also stimulate innovative ideas. For companies undertaking this journey, I suggest a log of comments that is regularly sent to managers from different departments.

### Links to More Information:

Maggie's Organics:  
[www.organicclothes.com/](http://www.organicclothes.com/)

Ann Arbor News Story:  
[blog.mlive.com/annarbornews/2008/09/my\\_business\\_maggies\\_organics\\_o.html??](http://blog.mlive.com/annarbornews/2008/09/my_business_maggies_organics_o.html??)

Treehugger:  
[www.treehugger.com/files/2008/09/maggies-organics-makes-sock-monkeys.php??](http://www.treehugger.com/files/2008/09/maggies-organics-makes-sock-monkeys.php??)

Sewing Cooperative in Nicaragua:  
[www.maggiesorganics.com/media/ants.wmv](http://www.maggiesorganics.com/media/ants.wmv)

Healthy Toy Rating:  
[www.healthytoys.org/home.php](http://www.healthytoys.org/home.php)

Contact Bena Burda:  
[benab@organicclothes.com](mailto:benab@organicclothes.com)



## Conclusion

Creating new “green jobs” is a hot topic. Based on our research, it is apparent that leading companies have already created millions of green jobs. Recognizing that environmental literacy is essential to job performance in the 21st century, they have taken steps to provide environmental education to their employees.

Environmentally educated employees can improve a business’ bottom line and help it reach its sustainability goals. In tough economic times, sustainability practices save money and reduce environment impact. By engaging their workforces, companies large and small can make changes to everyday business practices to green their businesses.

Responding to environmental challenges is now so fundamental to a company’s success that environmental knowledge cannot be isolated within an organization, but must be pervasive. In other words, all jobs are green jobs.

A few examples from our research help illustrate this trend:

- Johnson & Johnson has set environmental goals for many years. But as Tish Lascelle of Johnson & Johnson notes, “the low-hanging fruit for reducing our environmental impact is gone and we need to engage employees to identify the next level of environmentally friendly products and processes.” Johnson & Johnson has set goals and developed programs to encourage employee environmental literacy.
- As consumer interest in green buying has grown, some companies, including IKEA, are targeting education to sales employees so that they can respond intelligently when consumers ask questions about the environmental attributes of their products.
- For companies that sell to other companies, customer interest in greening the supply chain is a powerful motivator for engaging employees. The Accessory Corporation, a maker of hangers, completely rethought its product and manufacturing processes in response to customer interest in reducing packaging, waste and other environmental impacts.
- Meanwhile, companies with an all-encompassing environmental mission, including Clean Clothes, Inc. and Interface, are engaging their entire workforce in their strategic direction and creative problem solving with the goal of developing sustainable products.



Our survey confirms both the growing interest in and need for employee E&S education. The survey found that **65 percent** of respondents value job candidates’ E&S knowledge, while **78 percent** of respondents believe that the value of job candidates’ E&S knowledge will increase as a hiring factor within five years. In fact, many companies are already educating their employees about the environment: **75 percent** of companies educate employees about corporate E&S goals and **56 percent** of the respondents believe that their company has an advanced or very advanced E&S education program. Yet even the most advanced practitioners of employee E&S education and engagement acknowledge that there is a need to identify and share successful models, best practices and educational tools. This report is a step in that direction.

**Our survey confirms both the growing interest in and need for employee E&S education.**





## Lessons Learned

Companies are undertaking E&S education for a range of purposes, from enhancing their reputation among employees and communities to engaging employees in problem solving, to making the business case for sustainability.

The survey and case studies confirm both the growing interest in and need for employee E&S education. They also reveal that there is no single formula for success, as internal employee education approaches vary widely from company to company (see Figure 18: Case study matrix, pg. 14).

Despite this variety, the survey and case studies revealed common themes among companies with successful E&S education programs.

For several companies with effective programs, employee E&S education is part of the companies' culture, often beginning with the hiring process, as in the case of Clean Clothes, Inc. and Interface.

Successful programs often tie the education program to the company's mission and goals and performance evaluation processes.

Most of the companies studied also stressed the importance of involving all employees in a personal way. For example, Wal-Mart tailors information and makes it relevant to employees' personal lives as well as their jobs.

Companies including Stonyfield also emphasized that measuring E&S performance is critical to driving progress and as an education tool.

These organizations used a varied, creative set of methods to reach and influence employees including multi-departmental leadership, employee-led "green" teams, awards, online training, mixed-media communications, and performance incentives. In addition, several companies worked with external partners including NGOs to create successful E&S education programs, as in the case of Johnson & Johnson (see Figure 18: Case study matrix, pg. 14). Companies often used more than one organizational model for structuring their E&S education efforts, and the efforts extended beyond employees to include suppliers and customers.



## Needs Identified

Companies also face challenges when engaging employees in sustainability related initiatives. The survey and case study findings highlight six general needs related to E&S education:

1. Many companies cited the need for education tools to help them implement an E&S education program including case studies, success stories and training materials.
2. Companies repeatedly stated the desire for general as well as job-specific educational information to raise environmental awareness, and for information related to the business case for E&S education.
3. There also appears to be a need for trusted, third-party partnerships to help companies develop training materials, as well as to make the business case for E&S education.
4. Many companies were interested in learning how to reach out to employees who were not already interested in the environment or sustainability issues.
5. The need for appropriate indicators for measuring the impact of E&S education, beyond anecdotes, was a frequent concern.
6. Finally, a forum for identifying and sharing models and best practices related to E&S education is lacking.





## Appendix A. Survey questions

### 1. Which department do you work in at your company?

Marketing and Sales  
Communications  
Corporate Social Responsibility  
Environment, Health and Safety  
Facilities/Operations  
Human Resources  
Legal  
Procurement  
Public Affairs  
Other (please specify)

### 2. Which of the following best describes your position?

President, Owner, CEO  
Vice President  
Director  
Officer  
Manager  
Staff  
Other (please specify)

### 3. How many total employees are in your company?

1-99  
100-999  
1,000-9,999  
10,000-49,999  
50,000-99,000  
100,000+

### 4. What is your company's primary industry

Aerospace/Information Technology  
Automotive  
Chemical  
Computers & electronic products  
Consumer Products  
Diversified Industrial Goods and Services  
Electric Utility  
Electronics  
Energy  
Food/Agriculture Industry  
Forest Products  
Health Care & Health Care Products  
Imaging Products & Services  
Industrial & Institutional Appearance Protection  
Oil and Gas Production  
Packaging  
Pharmaceutical  
Semiconductor

Transportation Construction, Chemical and Petroleum  
Travel & Leisure (Cruise)  
Other (please specify)

### 5. Total revenue per year.

Decline to state  
Greater than \$25 billion  
\$10 - \$25 billion  
\$1 - \$10 billion  
\$100 million - \$1 billion  
\$1 - \$100 million  
Less than \$1 million

### 6. In which region is your company headquartered?

North America  
South America  
Europe  
Asia  
Middle East  
Africa  
Australia

### 7. If you would like to receive results of the survey please provide your name and email below. All results are confidential.

Name:  
Email:  
Company:  
May we contact you with follow-up questions?

### 8. What term is used at your company to describe "environmental" and "sustainability" activities?

Triple Bottom Line  
Sustainable Development  
Sustainable Growth  
Sustainability  
Corporate Social Responsibility (CSR)  
Corporate Environmental Responsibility (CER)  
Corporate Responsibility (CR)  
Corporate Citizenship  
Greening  
Environmental Stewardship  
Environmental Health and Safety (EHS)  
Other (please specify)

### 9. How much value does your company place on job candidates' environmental/sustainability knowledge?

A great deal  
Some  
Very little  
None



**10. How do you anticipate that the value of job candidates' environmental/sustainability knowledge or interest will change as a hiring factor in the next five years?**

- It will increase
- It will decrease
- It will stay about the same

**11. Does your company educate employees across the organization about its corporate environmental/sustainability goals?**

- Yes
- No

**12. How advanced is your company's environmental/sustainability education program?**

- Very advanced (High level of employee awareness that supports aligned values, strategy and operations)
- Advanced (High employee awareness and engagement, but some areas still need improvement)
- Improving (Some employee awareness is evident, but still need to change company culture and employee behavior)
- Taking first steps (Exploring ways to achieve this)

**13. Advanced Program Respondents: Which of the following topics does your company communicate about to educate employees about the environment/sustainability? (Select all that apply)**

- Greening the supply chain
- Harnessing sustainability as a foundation for innovation, new products and new markets
- General information about environmental/sustainability issues.
- Job-specific environmental/sustainability information.
- Environmental footprint of the company.
- Financial savings through environmental/sustainability practices.
- Actions at WORK to conserve or protect resources.
- Actions at HOME to conserve or protect resources.
- What the company is doing to conserve or protect resources.
- The company's environmental/sustainability successes and accomplishments.
- Employee environmental/sustainability success stories.
- Environmental regulations that the company must comply with.
- How the company is addressing climate change.
- Environmental/sustainability attributes of the company's products and services.
- Community impacts.
- Volunteer programs.
- Other (please specify)

**14. Below are different methods companies use to educate employees about its environmental/sustainability goals. We would like to know which are most effective from your perspective. Please rank the effectiveness of each of the following methods to educate and engage employees.**

- Award and recognition programs
- Community volunteer programs
- Competition among departments, facilities or business units
- Employee handbooks or policy documents
- Employee networks
- Hiring a consultant
- Incentives
- Internal "green teams"
- Internal communications campaign (multiple media)
- Online training modules
- Partnerships with nonprofits
- Product design guidelines
- Other/Our employees use more informal networks (please specify)

**15. Based on your experience, which 2-3 critical factors need to be in place to educate employees about the company's environmental/sustainability goals?**

**16. Advanced Program Respondents: In your opinion, what motivates employees to engage in corporate environmental/sustainability activities?**

- Customer loyalty
- Job satisfaction
- Improved company reputation
- Financial rewards
- General environmental/sustainability information related to corporate practices
- Concern for the environment and society
- Environmental/sustainability goals included in performance evaluation
- Regulatory requirements
- Evident CEO support or mandate
- Success stories about other employees' accomplishments
- Competition, either within the company or with direct competitors
- Internal peer champions
- Other (please specify)

**17. Advanced Program Respondents: What department has championed the company's environmental/sustainability education efforts?**

- Marketing and Sales
- Human Resources



Environmental Health and Safety  
Corporate Social Responsibility  
Procurement  
Internal communications  
Founder, CEO or President  
Employee volunteer  
Individual champion  
Other (please specify)

**18. Advanced Program Respondents: Which department is primarily responsible for employee environmental/sustainability education?**

Marketing and Sales  
Communications  
Corporate Social Responsibility  
Environmental Health and Safety  
Facilities/Operations  
Human Relations  
Legal  
Procurement  
Public Affairs  
I don't know  
Other (please specify)

**19. Beginner Program Respondents: Which of the following topics does your company communicate about to educate employees about the environment/sustainability? (Select all that apply)**

Greening the supply chain  
Harnessing sustainability as a foundation for innovation, new products, and new markets  
General information about environmental/sustainability issues.  
Job-specific environmental/sustainability information.  
Environmental footprint of the company.  
Financial savings through environmental/sustainability practices.  
Actions at WORK to conserve or protect resources.  
Actions at HOME to conserve or protect resources.  
What the company is doing to conserve or protect resources.  
The company's environmental/sustainability successes and accomplishments.  
Employee environmental/sustainability success stories.  
Environmental regulations that the company must comply with.  
How the company is addressing climate change.  
Environmental/sustainability attributes of the company's products and services.  
Community impacts.

Volunteer programs.  
Other (please specify)

**20. What have been three of the most important components of starting an employee environmental/sustainability education program at your company? (Please select no more than 3)**

Assess company's environmental and social impact  
CEO/executive leadership  
Conduct an internal employee survey  
Define values or principles  
Designate an internal employee champion  
Engage a nonprofit  
Form a multi-department environmental/sustainability team  
Host a kickoff event  
Research environmental/sustainability issues  
Secure CEO/executive buy-in  
Start an advisory committee  
Other (please specify)

**21. Beginner Program Respondents: What are the biggest internal hurdles to environmental/sustainability education in the company?**

**22. Beginner Program Respondents: In your opinion, what motivates employees to learn about their company's environmental/sustainability goals and activities?**

Competition, either within the company or with direct competitors  
Attracting and retaining talent  
Job satisfaction  
Customer loyalty  
Improved company reputation  
Financial rewards  
Evident CEO support or mandate  
Environmental/sustainability goals included in performance evaluation  
Concern for the environment and society  
General environmental/sustainability information related to corporate practices  
Internal peer champions  
Success stories about other employees' accomplishments  
External pressure  
Regulatory requirements  
Other (please specify)

**23. Beginner Program Respondents: What tools and resources would be helpful to start or improve your environmental/sustainability education efforts in your company?**



**24. Beginner Program Respondents: What department has championed the company's environmental/sustainability education efforts?**

- Marketing and Sales
- Human Resources
- Environment, Health and Safety
- Corporate Social Responsibility
- Procurement staff
- Internal communications
- Founder, CEO or President
- Employee volunteer
- Individual champion
- Other (please specify)

**25. Beginner Program Respondents: What department is primarily responsible for employee environmental/sustainability education?**

- Marketing and Sales
- Communications
- Corporate Social Responsibility
- Environment, Health and Safety
- Facilities/Operations
- Human Relations
- Legal
- Procurement
- Public Affairs
- I don't know
- Other (please specify)

**26. Does your company plan to start educating employees about its environmental/sustainability goals within the next two years?**

- Yes
- No
- Not sure

**27. No Program Respondents: If your company were to begin educating employees about its environmental/sustainability goals, which of the following topics would you like to see communicated about to employees? (Select all that apply)**

- General information about environmental/sustainability issues.
- Job-specific environmental/sustainability information.
- Environmental footprint of the company.
- Financial savings through environmental/sustainability practices.
- Actions at WORK to conserve or protect resources.
- Actions at HOME to conserve or protect resources.
- What the company is doing to conserve or protect resources.

- The company's environmental/sustainability successes and accomplishments.
- Employee environmental/sustainability success stories.
- Environmental regulations that the company must comply with.
- How the company is addressing climate change.
- Environmental/sustainability attributes of the company's products and services.
- Community impacts.
- Volunteer programs.
- Greening the supply chain.
- Harnessing sustainability as a foundation for innovation, new products and new markets.
- Other (please specify)

**28. No Program Respondents: What are the biggest internal hurdles to environmental/sustainability education in the company?**

**29. No Program Respondents: What tools and resources would be helpful to start employee environmental/sustainability education efforts in your company?**

**30. No Program Respondents: Which department would be primarily responsible for employee environmental/sustainability education?**

- Marketing and Sales
- Communications
- Corporate Social Responsibility
- Environment, Health and Safety
- Facilities/Operations
- Human Resources
- Legal
- Procurement
- Public Affairs
- I don't know
- Other (please specify)

**31. Which of the following best describes the primary reason why your company does not have or plan to implement an environmental/sustainability education program.**

- Too many other competing priorities
- Environment/sustainability isn't a big issue in my industry
- Lack of pressure from non-profit and community groups, competitors or other external parties
- Lack of time
- Company does not have environmental/sustainability goals at this time
- Lack of staff
- Lack of tools and resources
- Lack of environmental and social information
- Other (please specify)



## Appendix B. Case study questions

### Background:

Company: \_\_\_\_\_  
Name: \_\_\_\_\_  
Email: \_\_\_\_\_  
Position: \_\_\_\_\_  
Phone Number: \_\_\_\_\_  
Department: \_\_\_\_\_

### What function or department do you work in within your company?

EHS  
CSR  
Supply Chain  
Procurement  
Communication  
Public Affairs  
Community Outreach/Relations  
Human Resources  
Legal  
Other (please specify)

### Which of the following best describes your position?

President, Owner, CEO  
Vice President  
Director  
Officer  
Manager  
Staff  
Other (please specify)

### What is your company's primary industry?

### Total revenue per year. Choose one.

Decline to state  
Greater than \$25 billion  
\$10 - \$25 billion  
\$1 - \$10 billion  
\$100 million - \$1 billion  
\$1 - \$100 million  
Less than \$1 million

### How many total employees are in your company?

### In which region is your company headquartered?

North America  
South America  
Europe  
Asia  
Middle East  
Africa  
Australia

### Is your company a member of any trade associations that might be leveraged for environmental education?

### Recommendations for other companies to interview?

### Guiding Interview Questions:

#### 1. Tell me about your company's environmental education program:

How did your program get started? How many years has this been in place? What were the drivers?

What educational need does the program address?

Which education models, methods, and best practices does the company use? And, which are most effective?

How would your company define this type of initiative? (e.g. environmental awareness, employee engagement, employee education, etc)?

What are the key elements of the program?

What are the cultural aspects of company that might facilitate the success of this type of program?

How resource intensive is this model? Additional support? Resources? (Partnerships? Financial commitments from company?)

Have you had any major achievements or initiatives that paid off handsomely?

What were your challenges with the environmental education program, and how did you move through them? What key changes/improvements did you make along the way?





**2. Who is involved in environmental education within the company and how does environmental education fit into different business functions and the company as a whole?**

**And, who does what?**

Which departments primarily address CSR, environmental or social objectives? To whom do they report?

Which department (or individual) is ultimately responsible for environmental education? To whom does that department (or individual) report?

Which departments collaborate to increase environmental awareness within the company?

Who are the champions?

**4. What is important and motivating to employees as related to the environment/sustainability?**

What elements of this program do you think are most motivating employees?

How do your employees learn? (e.g. formal environmental education efforts, other employees, external sources, other companies, etc)?

**5. What employee feedback have you received about the environmental education program?**

In what ways (if any) has the environmental education been transformative for your company and employees?

Saving money?

Behavior changes?

Employees taking what they have learned home?

**6. How do you track or measure results?**

**7. What advice would offer to other companies?**

What would you do differently if starting over?

**8. What type of tools and resources are needed to help your company or other companies build programs in this area?**

Which tools are most useful?

Which are most effective?

What's missing? What tools/resources would be helpful to have?

How much did your current program cost?

**9. Do you have any artifacts, photos, etc for the environmental education program that you would be willing to share?**



**In the 21st century, all jobs are green jobs.**

**About the National Environmental Education Foundation**

The National Environmental Education Foundation (NEEF) provides knowledge to trusted professionals who, with their credibility, amplify messages to national audiences to solve everyday environmental problems. Together, we generate lasting positive change. NEEF works with professionals in health, education, public lands and the media to connect the environment to everyday choices and actions so the public can live well while protecting and enjoying the environment. Through our programs, such as Classroom Earth, National Public Lands Day, National Environmental Education Week, Earth Gauge® and our Pediatric Environmental History Initiative, we offer Americans knowledge to live by. To learn more, call (202) 833-2933 or visit [www.neefusa.org](http://www.neefusa.org).

**For more information about the survey findings or report, please contact Krista Gullo at [business@neefusa.org](mailto:business@neefusa.org).**



Business & Environment

is a program of



National Environmental  
Education Foundation

[www.neefusa.org](http://www.neefusa.org)  
4301 Connecticut Avenue, Suite 160  
Washington, DC 20008  
202-833-2933

© March 2009, National Environmental Education Foundation.